

HR BA **Tehnički list**

CLD-8904

**LED plafonjera**  
24W | 4000 K | IP20

- Osvjetljenje u stambenim prostorima, hodnicima i predsobljima, poslovnim prostorima, dekorativni element...
- Moderan dizajn
- MLS LED
- IP20



## Osnovne informacije

• Model	CLD-8904
• LED diode	MLS
• Materijal	Željezna baza + akrilni poklopac + PP prsten
• Okruženje	Unutarnja rasvjeta
• Boja artikla	Bijela + crna + zlatna
• Radna temperatura	od - 5 °C do 85 °C
• Način montaže	Nadgradna montaža
• IP stupanj zaštite	IP20
• Neto težina	

## Električne specifikacije

• Snaga	24 W
• Napon	AC 220 - 240 V / 50 - 60 Hz
• Dimabilnost	Ne
• Driver	Neizoliran
• Mogućnost zamjene LED dioda	Ne
• Mogućnost zamjene LED driver-a	Ne

## Osvjetljenje

• FLUX	2880 lm
• Svjetlosna učinkovitost	120 lm / W
• Boja svjetlosti	Neutralna/dnevna
• CCT	4000 K
• Indeks prikaza boja (CRI)	≥ 80
• PF	0.5
• Kut svjetlosti	140°
• Radni vijek	2 godine

## Informacije o pakiranju

• Dimenzije pakiranja	400 x 80 x 400 mm
• Bruto težina	
• Transportno pakiranje	

## Dimenzije

- Dimenzije artikla

Ø 390 x 75 mm

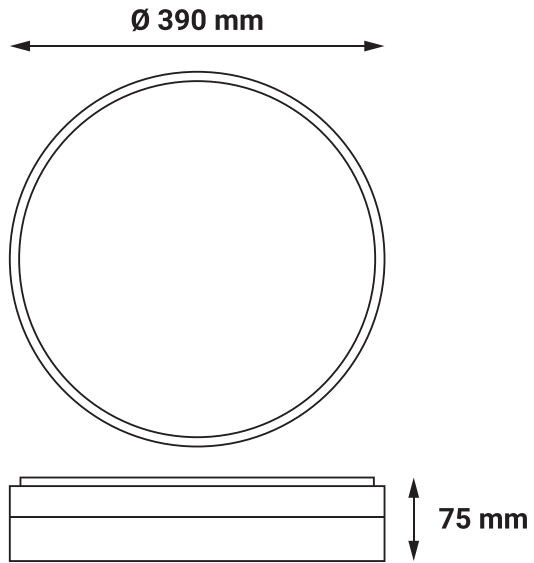

## SI Podatkovni list izdelka

CLD-8904

**LED stropna svetilka**  
24W | 4000 K | IP20

- Razsvetljava v stanovanjskih prostorih, hodnikih in predverjih, poslovnih prostorih, dekorativnih elementih...
- Sodobno oblikovno zasnovano
- MLS LED
- IP20



## Osnovni podatki

• Model	CLD-8904
• LED diode	MLS
• Material	Železna osnova + akrilni pokrov + PP obroč
• Okolje	Notranja razsvetljava
• Barva izdelka	Bela + črna + zlata
• Delovna temperatura	od - 5 °C do 85 °C
• Način montaže	Površinska montaža
• IP stopnja	IP20
• Neto teža	

## Električne specifikacije

• Moč	24 W
• Napetost	AC 220 - 240 V / 50 - 60 Hz
• Zatamnitev	Ne
• Driver	Neizolirano
• Možnost zamenjave LED diod	Ne
• Možnost zamenjave LED driver-a	Ne

## Osvetlitev

• FLUX	2880 lm
• Svetlobna učinkovitost	120 lm / W
• Barva svetlobe	Nevtralna/dnevna
• CCT	4000 K
• Indeks barvne reprodukcije (CRI)	≥ 80
• PF	0.5
• Svetlobni kot	140°
• Življenjska doba	2 leti

## Informacije o embalaži

• Dimenzije paketa	400 x 80 x 400 mm
• Bruto teža	
• Transportna embalaža	

## Dimenzije

- Dimenzije izdelka

Ø 390 x 75 mm

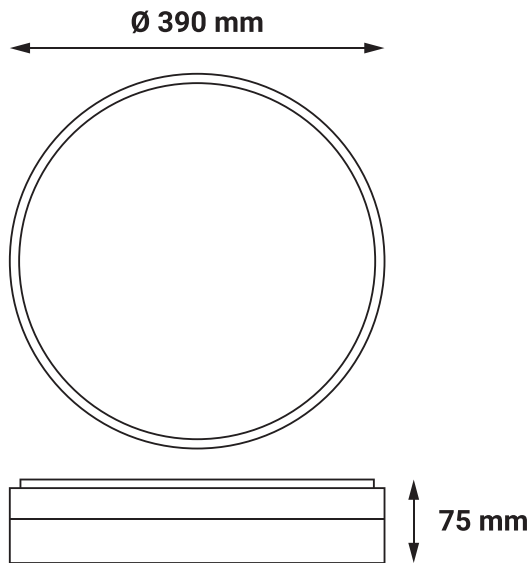



## DE Produktdatenblatt

CLD-8904

**LED-Deckenleuchten**  
24W | 4000 K | IP20

- Beleuchtung in Wohnräumen, Fluren und Foyers, Geschäftsräumen, dekorative Elemente...
- Modernes Design
- MLS LED
- IP20



## Allgemeine Informationen

• Modell	CLD-8904
• LED Diode	MLS
• Material	Eisenfuß + Acrylabdeckung + PP-Ring
• Umgebung	Innenbeleuchtung
• Produktfarbe	Weiß + Schwarz + Gold
• Betriebstemperatur	von - 5 °C bis 85 °C
• Montage	Oberflächenmontage
• IP-Schutzart	IP20
• Nettogewicht	

## Elektrische Spezifikationen

• Leistung	24 W
• Spannung	AC 220 - 240 V / 50 - 60 Hz
• Dimmbare Funktion	Nein
• Driver	Nicht isoliert
• LED auswechseln	Nein
• LED Driver auswechseln	Nein

## Beleuchtung

• FLUX	2880 lm
• Lichtausbeute	120 lm / W
• Helle Farbe	Neutral/Tageslicht
• CCT	4000 K
• Farbwiedergabeindex (CRI)	≥ 80
• PF	0.5
• Lichtwinkel	140°
• Lebensdauer	2 Jahre

## Verpackungsinformationen

- |                              |                   |
|------------------------------|-------------------|
| • Abmessungen der Verpackung | 400 x 80 x 400 mm |
|------------------------------|-------------------|
- Bruttogewicht
  - Abmessungen der Transportverpackung

## Abmessungen

- Abmessungen des Produkts

Ø 390 x 75 mm

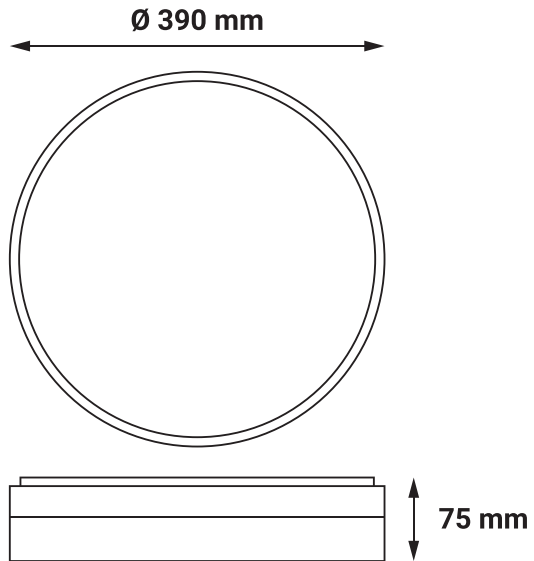

## EN Product datasheet

CLD-8904

**LED ceiling light**  
24W | 4000 K | IP20

- Lighting in residential spaces, hallways, and foyers, commercial spaces, decorative element...
- Modern design
- MLS LED
- IP20



## General informations

• Model	CLD-8904
• LED chip	MLS
• Body material	Iron base + Acrylic cover + PP ring
• Environment	Indoor lighting
• Product color	White + Black + Gold
• Operating temperature	from - 5 °C to 85 °C
• Mounting	Surface mounting
• IP protection rate	IP20
• Weight	

## Electrical specifications

• Power consumption	24 W
• Voltage	AC 220 - 240 V / 50 - 60 Hz
• Dimmable	No
• Driver	Non-isolated
• Replacing LED	No
• Replacing power supply	No

## Lightning

• FLUX	2880 lm
• Luminous efficiency	120 lm / W
• Color of the light	Neutral/day light
• CCT	4000 K
• Color Render Index (CRI)	≥ 80
• DF	0.5
• Beam angle	140°
• Life span	2 years

## Packaging information

• Package dimensions	400 x 80 x 400 mm
• Gross weight	
• Transport package	

## Dimensions

- Product dimensions

Ø 390 x 75 mm

