

save energy | save planet | save future   
**Green tech**

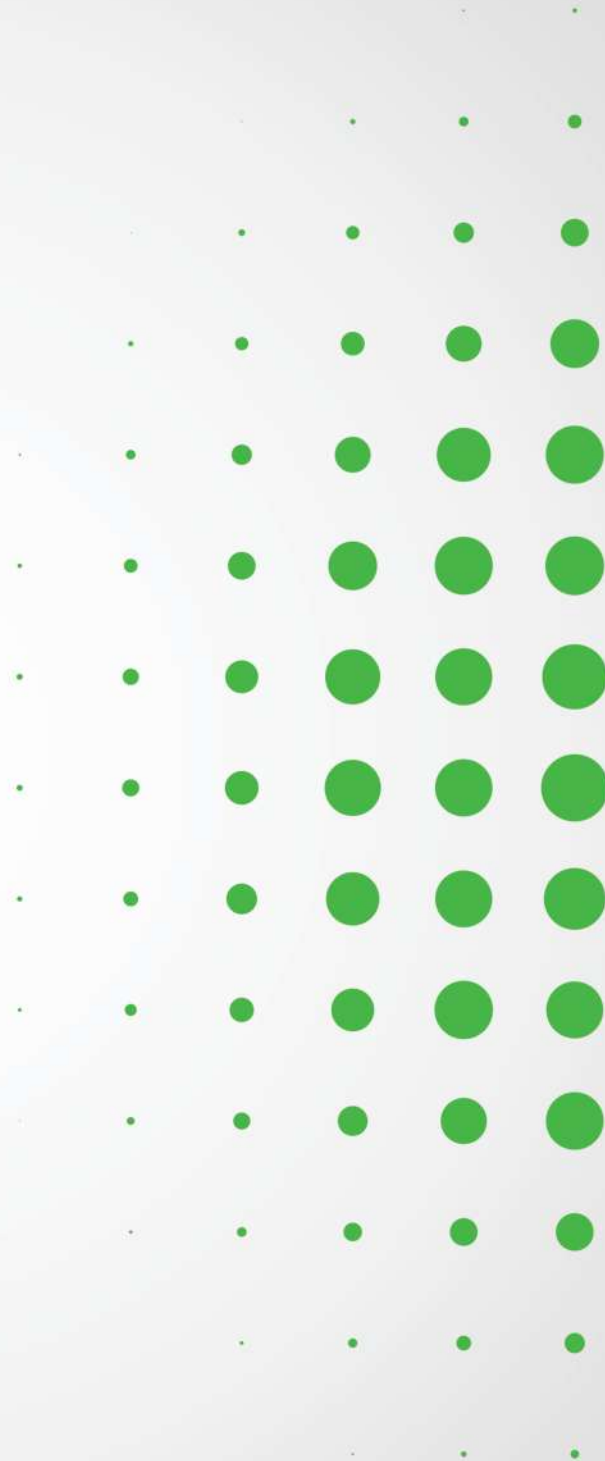
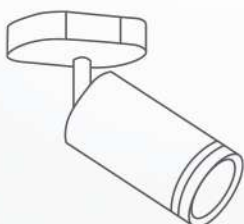
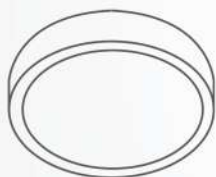
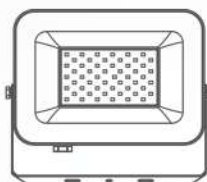
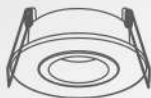

# KATALOG

## LED RASVJETA

[www.greentech-solution.eu](http://www.greentech-solution.eu)



### **Snaga (W)**

Snaga LED svjetiljke izražena u vatima (W). Označava potrošnju energije uređaja.

### **Boja svjetlosti (CCT)**

Temperatura svjetlosnog izvora izražena u kelvinima (K).

### **Lumen (lm)**

Oznaka lm ili lumen označava svjetlosni tok, tj. ukupnu količinu vidljive svjetlosti koju svjetlosni izvor (npr. LED svjetiljka ili žarulja) emitira. To je standardna jedinica u SI sustavu za mjerenje intenziteta svjetlosti koju ljudsko oko može percipirati.

### **IP zaštita (IP)**

Oznaka IP (Ingress Protection) u tehničkoj specifikaciji LED svjetiljke označava stepen zaštite uređaja od prašine i vode.

### **IK zaštita (IK)**

Oznaka IK označava otpornost uređaja na udarce, tj. razinu mehaničke zaštite kućišta od vanjskih fizičkih utjecaja poput udaraca, oštećenja i vandalizma. IK oznaka je definirana prema međunarodnom standardu EN 62262 (IEC 62262) i koristi se za ocjenu robusnosti uređaja ili kućišta.

### **Dimabilnost**

Dimabilnost (engl. dimmability) označava sposobnost svjetiljke, žarulje ili drugog svjetlosnog izvora da mijenja intenzitet svjetlosti, tj. da se priguši ili pojača prema potrebama korisnika. Dimabilne svjetiljke omogućuju podešavanje jačine osvjjetljenja za različite uvjete i atmosfere, čime se poboljšava udobnost, funkcionalnost i energetska učinkovitost.



08 - 19

LED žarulje

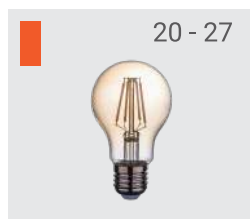

20 - 27

LED filament žarulje



28 - 39

LED paneli i okviri

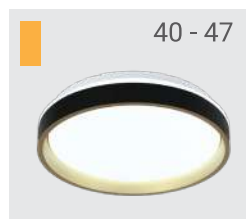

40 - 47

LED plafonjere



48 - 51

LED plafonjere sa senzorom



52 - 67

LED spot svjetiljke

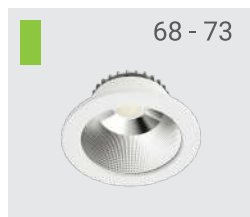

68 - 73

LED downlight

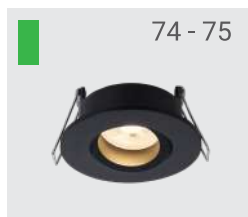

74 - 75

Rozetne



76 - 79

Zidne lampe

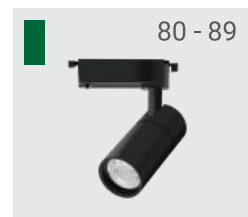

80 - 89

Šinska rasvjeta



90 - 113

Magnetna šinska rasvjeta



114 - 117

LED kupaonske lampe



118 - 127

LED reflektori



128 - 131

LED cestovna rasvjeta



132 - 147

Cestovni i parkovski stubovi

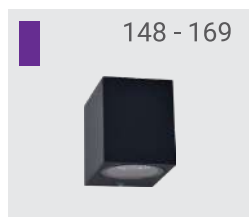

148 - 169

Vanjska zidna rasvjeta



170 - 173

Vanjska podna rasvjeta



174 - 179

Vrtna rasvjeta



180 - 183

LED industrijske visilice



184 - 187

LED vodotijesne svjetiljke



188 - 191

LED cijevi



192 - 197

LED nužna rasvjeta



198 - 205

LED linearne svjetiljke

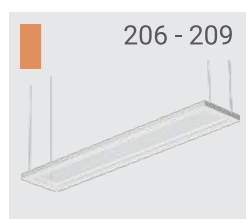

206 - 209

LED uredske visilice



210 - 219

Aluminijski profili



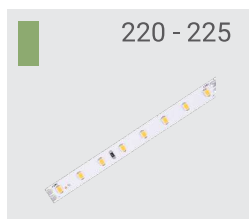

220 - 225

LED trake

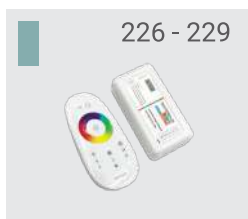

226 - 229

LED kontroleri,  
pojačala i dimmeri

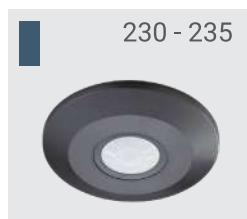

230 - 235

Senzori i detektori

LED žarulje.....	08 - 19
LED filament žarulje.....	20 - 27
LED paneli i okviri.....	28 - 39
LED plafonjere.....	40 - 47
LED plafonjere sa senzorom.....	48 - 51
LED spot svjetiljke.....	52 - 67
LED downlight.....	68 - 73
Rozetne.....	74 - 75
Zidne lampe.....	76 - 79
Šinska rasvjeta.....	80 - 89
Magnetna šinska rasvjeta.....	90 - 113
LED kupaonske lampe.....	114 - 117
LED reflektori.....	118 - 127
LED cestovna rasvjeta.....	128 - 131
Cestovni i parkovski stubovi.....	132 - 147
Vanjska zidna rasvjeta.....	148 - 169
Vanjska podna rasvjeta.....	170 - 173
Vrtna rasvjeta.....	174 - 179
LED industrijske visilice.....	180 - 183
LED vodotijesne svjetiljke.....	184 - 187
LED cijevi.....	188 - 191
LED nužna rasvjeta.....	192 - 197
LED linearne svjetiljke.....	198 - 205
LED uredske visilice.....	206 - 209
Aluminijski profili.....	210 - 219
LED trake.....	220 - 225
LED kontroleri, pojačala i dimmeri.....	226 - 229
Senzori i detektori.....	230 - 235





## LED ŽARULJE

LED žarulje predstavljaju energetski učinkovito i dugotrajno rješenje za različite potrebe osvetljenja. Svojom naprednom tehnologijom pružaju visoku svjetlosnu učinkovitost uz minimalnu potrošnju energije, čineći ih ekološki prihvatljivim izborom. Idealne su za kućnu i poslovnu upotrebu, te dolaze u različitim oblicima, veličinama i temperaturama boje kako bi zadovoljile sve vaše zahtjeve za osvetljenjem.

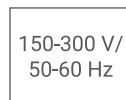
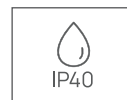

ID proizvoda	Snaga	CCT	Oblik žarulje	Dimenzije	Napon
BLX-6100	6W	● 3000 K	G45	Ø 45 x 80 mm	150 - 300 V
BLX-6101	6W	● 4000 K	G45	Ø 45 x 80 mm	150 - 300 V



ID proizvoda	Snaga	CCT	Oblik žarulje	Dimenzije	Napon
BLX-6107	6W	● 3000 K	A60	Ø 60 x 110 mm	150 - 300 V
BLX-6108	6W	● 4000 K	A60	Ø 60 x 110 mm	150 - 300 V
BLX-6109	6W	● 6000 K	A60	Ø 60 x 110 mm	150 - 300 V
BLX-6111	10W	● 3000 K	A60	Ø 60 x 110 mm	150 - 300 V
BLX-6112	10W	● 4000 K	A60	Ø 60 x 110 mm	150 - 300 V
BLX-6113	10W	● 6000 K	A60	Ø 60 x 110 mm	150 - 300 V
BLX-6115	12W	● 3000 K	A60	Ø 60 x 110 mm	150 - 300 V
BLX-6116	12W	● 4000 K	A60	Ø 60 x 110 mm	150 - 300 V

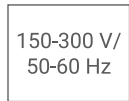

ID proizvoda	Snaga	CCT	Oblik žarulje	Dimenzije	Napon
BLX-6124	7W	● 4000 K	T37	Ø 40 x 103 mm	150 - 300 V



ID proizvoda	Snaga	CCT	Oblik žarulje	Dimenzije	Napon
BLX-6153	15W	● 4000 K	B65	Ø 65 x 150 mm	150 - 300 V
BLX-6162	30W	● 4000 K	B90	Ø 90 x 210 mm	150 - 300 V



ID proizvoda	Snaga	CCT	Oblik žarulje	Dimenzije	Napon
BLX-6177	30W	● 6500 K	T100	Ø 95 x 180 mm	150 - 300 V
BLX-6180	40W	● 6500 K	T120	Ø 115 x 200 mm	150 - 300 V



150-300 V/  
50-60 Hz

ID proizvoda	Snaga	CCT	Oblik žarulje	Dimenzije	Napon
LB-2116	15W	● 3000 K	A60	Ø 60 x 120 mm	150 - 300 V
LB-2117	15W	● 4000 K	A60	Ø 60 x 120 mm	150 - 300 V
LB-2118	15W	● 6000 K	A60	Ø 60 x 120 mm	150 - 300 V



220-240 V/  
50-60 Hz

ID proizvoda	Snaga	CCT	Oblik žarulje	Dimenzije	Napon
BLX-6245	9W	● 4500 K	R63	Ø 63 x 100 mm	220 - 240 V

## LED ŽARULJE



110-240 V/  
50-60 Hz



ID proizvoda	Snaga	CCT	Oblik žarulje	Dimenzije	Napon
TUYA-A60-9W	9W	RGB + W	A60	Ø 60 x 120 mm	110 - 240 V



165-265 V/  
50-60 Hz

ID proizvoda	Snaga	CCT	Oblik žarulje	Dimenzije	Napon
LBD-4000	12W	4200 K	A65	Ø 65 x 120 mm	165 - 265 V
LBD-4001	12W	3000 K	A65	Ø 65 x 120 mm	165 - 265 V



150-300 V/  
50-60 Hz

ID proizvoda	Snaga	CCT	Oblik žarulje	Dimenzije	Napon
BLX-6241	5W	4000 K	R50	Ø 50 x 85 mm	150 - 300 V



## LED ŽARULJE



220-240 V/  
50-60 Hz

ID proizvoda	Snaga	CCT	Oblik žarulje	Dimenzije	Napon
BLX-7005	7W	● 4000 K	R50	Ø 50 x 82 mm	220 - 240 V



150-300 V/  
50-60 Hz

ID proizvoda	Snaga	CCT	Oblik žarulje	Dimenzije	Napon
LB-2230	5W	● 3000 K	G45	Ø 45 x 80 mm	150 - 300 V
LB-2231	5W	● 4000 K	G45	Ø 45 x 80 mm	150 - 300 V



220-240 V/  
50-60 Hz

ID proizvoda	Snaga	CCT	Oblik žarulje	Dimenzije	Napon
LB-1302	5W	● 4000 K	G45	Ø 45 x 80 mm	220 - 240 V

## LED ŽARULJE

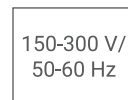
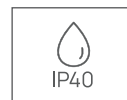

ID proizvoda	Snaga	CCT	Oblik žarulje	Dimenzije	Napon
LB-2200	5W	● 3000 K	C37	Ø 35 x 100 mm	150 - 300 V
LB-2201	5W	● 4000 K	C37	Ø 35 x 100 mm	150 - 300 V
LB-2205	7W	● 3000 K	C37	Ø 35 x 100 mm	150 - 300 V

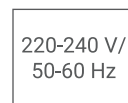

ID proizvoda	Snaga	CCT	Oblik žarulje	Dimenzije	Napon
LB-1201	5W	● 3000 K	C37	Ø 37 x 100 mm	220 - 240 V
LB-1202	5W	● 4000 K	C37	Ø 37 x 100 mm	220 - 240 V
LB-1203	5W	● 6000 K	C37	Ø 37 x 100 mm	220 - 240 V
LB-1204	7W	● 3000 K	C37	Ø 37 x 100 mm	220 - 240 V
LB-1205	7W	● 4000 K	C37	Ø 37 x 100 mm	220 - 240 V
LB-1206	7W	● 6000 K	C37	Ø 37 x 100 mm	220 - 240 V

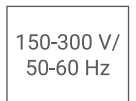

ID proizvoda	Snaga	CCT	Oblik žarulje	Dimenzije	Napon
LB-2404	3W	● 4000 K	A3	Ø 47 x 55 mm	150 - 300 V
LB-2407	5W	● 4000 K	A3	Ø 47 x 55 mm	150 - 300 V
LB-2408	5W	● 6000 K	A3	Ø 47 x 55 mm	150 - 300 V
LB-2409	7W	● 3000 K	A3	Ø 47 x 55 mm	150 - 300 V

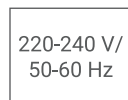

ID proizvoda	Snaga	CCT	Oblik žarulje	Dimenzije	Napon
LB-1001	3W	● 3000 K	GU10	Ø 50 x 55 mm	220 - 240 V
LB-1002	3W	● 4000 K	GU10	Ø 50 x 55 mm	220 - 240 V
LB-1003	3W	● 6000 K	GU10	Ø 50 x 55 mm	220 - 240 V
LB-1004	5W	● 3000 K	GU10	Ø 50 x 55 mm	220 - 240 V
LB-1005	5W	● 4000 K	GU10	Ø 50 x 55 mm	220 - 240 V
LB-1006	5W	● 6000 K	GU10	Ø 50 x 55 mm	220 - 240 V
LB-1007	7W	● 3000 K	GU10	Ø 50 x 55 mm	220 - 240 V
LB-1008	7W	● 4000 K	GU10	Ø 50 x 55 mm	220 - 240 V
LB-1009	7W	● 6000 K	GU10	Ø 50 x 55 mm	220 - 240 V



ID proizvoda	Snaga	CCT	Oblik žarulje	Dimenzije	Napon
LB-1010	9W	● 3000 K	GU10	Ø 50 x 64 mm	220 - 240 V
LB-1011	9W	● 4000 K	GU10	Ø 50 x 64 mm	220 - 240 V
LB-1012	9W	● 6000 K	GU10	Ø 50 x 64 mm	220 - 240 V

## LED ŽARULJE

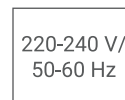
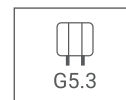

ID proizvoda	Snaga	CCT	Oblik žarulje	Dimenzije	Napon
LB-1101	5W	● 3000 K	MR16	Ø 50 x 50 mm	220 - 240 V
LB-1102	5W	● 4000 K	MR16	Ø 50 x 50 mm	220 - 240 V
LB-1103	5W	● 6000 K	MR16	Ø 50 x 50 mm	220 - 240 V
LB-1104	7W	● 3000 K	MR16	Ø 50 x 50 mm	220 - 240 V
LB-1105	7W	● 4000 K	MR16	Ø 50 x 50 mm	220 - 240 V
LB-1106	7W	● 6000 K	MR16	Ø 50 x 50 mm	220 - 240 V

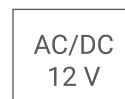

ID proizvoda	Snaga	CCT	Oblik žarulje	Dimenzije	Napon
LB-1110	5W	● 3000 K	MR16	Ø 50 x 50 mm	AC/DC 12 V
LB-1111	5W	● 4000 K	MR16	Ø 50 x 50 mm	AC/DC 12 V

## LED ŽARULJE



176-265 V/  
50-60 Hz

ID proizvoda	Snaga	CCT	Tip grla	Dimenzije	Napon
LB-2730	2W	● 3000 K	G9	Ø 15 x 50 mm	176 - 265 V

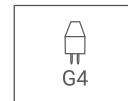

DC 12 V

ID proizvoda	Snaga	CCT	Tip grla	Dimenzije	Napon
LB-3651	2W	● 4000 K	G4	Ø 15 x 45 mm	DC 12 V

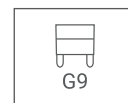

220-240 V/  
50-60 Hz

ID proizvoda	Snaga	CCT	Oblik žarulje	Dimenzije	Napon
LB-4002	2W	● 4000 K	G9	Ø 14 x 50 mm	220 - 240 V

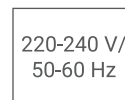
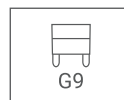

ID proizvoda	Snaga	CCT	Tip grla	Dimenzije	Napon
LB-4003	4W	● 3000 K	G9	Ø 17 x 55 mm	220 - 240 V
LB-4004	4W	● 4000 K	G9	Ø 17 x 55 mm	220 - 240 V



## LED **FILAMENT** ŽARULJE

LED filament žarulje spajaju klasičan retro izgled sa suvremenom LED tehnologijom. Njihov dizajn oponaša izgled tradicionalnih žarulja sa žarnom niti, dok istovremeno nude prednosti visoke energetske učinkovitosti i dugog vijeka trajanja. Savršene su za stvaranje toplog i ugodnog ambijenta u interijerima, zadržavajući stilsku privlačnost vintage rasvjete.



## LED FILAMENT ŽARULJE

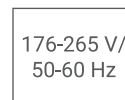

ID proizvoda	Snaga	CCT	Oblik žarulje	Dimenzije	Napon
LFB-3002	4W	● 2300 K	A60	Ø 60 x 100 mm	176 - 265 V



ID proizvoda	Snaga	CCT	Oblik žarulje	Dimenzije	Napon
LFB-3012	4W	● 2300 K	ST64	Ø 65 x 140 mm	176 - 265 V

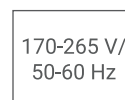

ID proizvoda	Snaga	CCT	Oblik žarulje	Dimenzije	Napon
LFB-3310	6W	● 2700 K	G95	Ø 95 x 140 mm	170 - 265 V

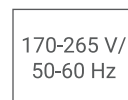

ID proizvoda

Snaga

CCT

Oblik žarulje

Dimenzije

Napon

LFB-4000

4W

● 2700 K

G95

125 x 170 mm

170 - 265 V



ID proizvoda

Snaga

CCT

Oblik žarulje

Dimenzije

Napon

LFB-4001

4W

● 2700 K

G95

95 x 95 mm

170 - 265 V

220-240 V/  
50-60 Hz

ID proizvoda	Snaga	CCT	Oblik žarulje	Dimenzije	Napon
LFB-5001	4W	● 2300 K	A60	Ø 60 x 108 mm	220 - 240 V
LFB-5002	8W	● 2300 K	A60	Ø 60 x 108 mm	220 - 240 V
LFB-5003	12W	● 2300 K	A60	Ø 60 x 108 mm	220 - 240 V



ID proizvoda	Snaga	CCT	Oblik žarulje	Dimenzije	Napon
LFB-5301	8W	● 2300 K	ST64	Ø 64 x 145 mm	220 - 240 V
LFB-5202	6W	● 2300 K	ST64	Ø 64 x 145 mm	220 - 240 V



170-265 V/  
50-60 Hz

ID proizvoda

Snaga

CCT

Oblik žarulje

Dimenzije

Napon

LFB-3210

4W

● 2700 K

C35

Ø 35 x 100 mm

170 - 265 V



220-240 V/  
50-60 Hz

ID proizvoda

Snaga

CCT

Oblik žarulje

Dimenzije

Napon

LFB-5101

4W

● 2300 K

C35T

Ø 35 x 115 mm

220 - 240 V

LFB-5102

6W

● 2300 K

C35T

Ø 35 x 115 mm

220 - 240 V

## LED FILAMENT ŽARULJE

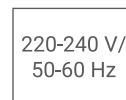

ID proizvoda	Snaga	CCT	Oblik žarulje	Dimenzije	Napon
LFB-5201	4W	● 2700 K	C35	Ø 35 x 98 mm	220 - 240 V
LFB-5202	6W	● 2300 K	C35	Ø 35 x 98 mm	220 - 240 V



ID proizvoda	Snaga	Tip grla	Dimenzije
LHS-5M	max. 8 x 40 W	8 x E27	5 m + 2,5 m kabela 2 x 1.0 m <sup>2</sup>
LHS-10M	max. 16 x 40 W	16 x E27	10 m + 2,5 m kabela 2 x 1.0 m <sup>2</sup>





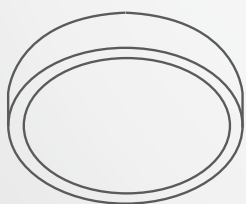

## LED PANELI I OKVIRI

LED paneli i okviri nude suvremeno rješenje za ravnomjerno i učinkovito osvjetljenje prostora. Svojim minimalističkim dizajnom i visokom svjetlosnom učinkovitošću idealni su za poslovne i stambene objekte. Paneli pružaju ugodno svjetlo, dok okviri omogućuju jednostavnu ugradnju i prilagodljivost različitim prostorima, uz niz opcija za montažu.





85-240 V/  
50-60 Hz

ID proizvoda	Snaga	CCT	Lumen	Dimenzije	Napon
CX-R01-3-3CCT	3W	<b>3 U 1</b> 3000 K   4000 K   6500 K	240 lm	Ø 82 x 25 mm	85 - 240 V
CX-R01-6-3CCT	6W	<b>3 U 1</b> 3000 K   4000 K   6500 K	480 lm	Ø 116 x 25 mm	85 - 240 V
CX-R01-12-3CCT	12W	<b>3 U 1</b> 3000 K   4000 K   6500 K	960 lm	Ø 170 x 25 mm	85 - 240 V
CX-R01-18-3CCT	18W	<b>3 U 1</b> 3000 K   4000 K   6500 K	1440 lm	Ø 220 x 25 mm	85 - 240 V
CX-R01-24-3CCT	24W	<b>3 U 1</b> 3000 K   4000 K   6500 K	1920 lm	Ø 295 x 25 mm	85 - 240 V







ID proizvoda	Snaga	CCT	Lumen	Dimenzije	Napon
CX-R02-6-3CCT	6W	<b>3 U 1</b> 3000 K   4000 K   6500 K	480 lm	Ø 110 x 40 mm	85 - 240 V
CX-R02-12-3CCT	12W	<b>3 U 1</b> 3000 K   4000 K   6500 K	960 lm	Ø 160 x 40 mm	85 - 240 V
CX-R02-18-3CCT	18W	<b>3 U 1</b> 3000 K   4000 K   6500 K	1440 lm	Ø 210 x 40 mm	85 - 240 V
CX-R02-24-3CCT	24W	<b>3 U 1</b> 3000 K   4000 K   6500 K	1920 lm	Ø 290 x 40 mm	85 - 240 V

85-240 V/  
50-60 Hz

ID proizvoda	Snaga	CCT	Lumen	Dimenzije	Napon
CX-S01-3-3CCT	3W	 <b>3 U 1</b> 3000 K   4000 K   6500 K	240 lm	82 x 82 x 25 mm	85 - 240 V
CX-S01-6-3CCT	6W	 <b>3 U 1</b> 3000 K   4000 K   6500 K	480 lm	116 x 116 x 25 mm	85 - 240 V
CX-S01-12-3CCT	12W	 <b>3 U 1</b> 3000 K   4000 K   6500 K	960 lm	170 x 170 x 25 mm	85 - 240 V
CX-S01-18-3CCT	18W	 <b>3 U 1</b> 3000 K   4000 K   6500 K	1440 lm	220 x 220 x 25 mm	85 - 240 V
CX-S01-24-3CCT	24W	 <b>3 U 1</b> 3000 K   4000 K   6500 K	1920 lm	295 x 295 x 25 mm	85 - 240 V



ID proizvoda	Snaga	CCT	Lumen	Dimenzije	Napon
CX-S02-6-3CCT	6W	 <b>3 U 1</b> 3000 K   4000 K   6500 K	480 lm	110 x 110 x 40 mm	85 - 240 V
CX-S02-12-3CCT	12W	 <b>3 U 1</b> 3000 K   4000 K   6500 K	960 lm	160 x 160 x 40 mm	85 - 240 V
CX-S02-18-3CCT	18W	 <b>3 U 1</b> 3000 K   4000 K   6500 K	1440 lm	210 x 210 x 40 mm	85 - 240 V
CX-S02-24-3CCT	24W	 <b>3 U 1</b> 3000 K   4000 K   6500 K	1920 lm	290 x 290 x 40 mm	85 - 240 V

85-265 V/  
50-60 Hz

ID proizvoda	Snaga	CCT	Lumen	Dimenzije	Napon
CX-R01-3WW	3W	● 3000 K	300 lm	Ø 82 x 28 mm	85 - 265 V
CX-R01-3NW	3W	● 4200 K	300 lm	Ø 82 x 28 mm	85 - 265 V
CX-R01-3CW	3W	● 6500 K	300 lm	Ø 82 x 28 mm	85 - 265 V
CX-R01-6WW	6W	● 3000 K	600 lm	Ø 115 x 28 mm	85 - 265 V
CX-R01-6NW	6W	● 4200 K	600 lm	Ø 115 x 28 mm	85 - 265 V
CX-R01-6CW	6W	● 6500 K	600 lm	Ø 115 x 28 mm	85 - 265 V
CX-R01-12WW	12W	● 3000 K	1200 lm	Ø 168 x 28 mm	85 - 265 V
CX-R01-12NW	12W	● 4200 K	1200 lm	Ø 168 x 28 mm	85 - 265 V
CX-R01-12CW	12W	● 6500 K	1200 lm	Ø 168 x 28 mm	85 - 265 V
CX-R01-18WW	18W	● 3000 K	1800 lm	Ø 220 x 28 mm	85 - 265 V
CX-R01-18NW	18W	● 4200 K	1800 lm	Ø 220 x 28 mm	85 - 265 V
CX-R01-18CW	18W	● 6500 K	1800 lm	Ø 220 x 28 mm	85 - 265 V
CX-R01-24WW	24W	● 3000 K	2400 lm	Ø 295 x 28 mm	85 - 265 V
CX-R01-24NW	24W	● 4200 K	2400 lm	Ø 295 x 28 mm	85 - 265 V
CX-R01-24CW	24W	● 6500 K	2400 lm	Ø 295 x 28 mm	85 - 265 V

85-265 V/  
50-60 Hz

ID proizvoda	Snaga	CCT	Lumen	Dimenzije	Napon
CX-R02-6WW	6W	● 3000 K	300 lm	Ø 110 x 40 mm	85 - 265 V
CX-R02-6NW	6W	● 4200 K	300 lm	Ø 110 x 40 mm	85 - 265 V
CX-R02-6CW	6W	● 6500 K	300 lm	Ø 110 x 40 mm	85 - 265 V
CX-R02-12WW	12W	● 3000 K	600 lm	Ø 160 x 40 mm	85 - 265 V
CX-R02-12NW	12W	● 4200 K	600 lm	Ø 160 x 40 mm	85 - 265 V
CX-R02-12CW	12W	● 6500 K	600 lm	Ø 160 x 40 mm	85 - 265 V
CX-R02-18WW	18W	● 3000 K	1200 lm	Ø 210 x 40 mm	85 - 265 V
CX-R02-18NW	18W	● 4200 K	1200 lm	Ø 210 x 40 mm	85 - 265 V
CX-R02-18CW	18W	● 6500 K	1200 lm	Ø 210 x 40 mm	85 - 265 V
CX-R02-24WW	24W	● 3000 K	1800 lm	Ø 285 x 40 mm	85 - 265 V
CX-R02-24NW	24W	● 4200 K	1800 lm	Ø 285 x 40 mm	85 - 265 V
CX-R02-24CW	24W	● 6500 K	1800 lm	Ø 285 x 40 mm	85 - 265 V

85-265 V/  
50-60 Hz

ID proizvoda	Snaga	CCT	Lumen	Dimenzije	Napon
CX-S01-3WW	3W	● 3000 K	300 lm	82 x 82 x 28 mm	85 - 265 V
CX-S01-3NW	3W	● 4200 K	300 lm	82 x 82 x 28 mm	85 - 265 V
CX-S01-3CW	3W	● 6500 K	300 lm	82 x 82 x 28 mm	85 - 265 V
CX-S01-6WW	6W	● 3000 K	600 lm	115 x 115 x 28 mm	85 - 265 V
CX-S01-6NW	6W	● 4200 K	600 lm	115 x 115 x 28 mm	85 - 265 V
CX-S01-6CW	6W	● 6500 K	600 lm	115 x 115 x 28 mm	85 - 265 V
CX-S01-12WW	12W	● 3000 K	1200 lm	170 x 170 x 28 mm	85 - 265 V
CX-S01-12NW	12W	● 4200 K	1200 lm	170 x 170 x 28 mm	85 - 265 V
CX-S01-12CW	12W	● 6500 K	1200 lm	170 x 170 x 28 mm	85 - 265 V
CX-S01-18WW	18W	● 3000 K	1800 lm	220 x 220 x 28 mm	85 - 265 V
CX-S01-18NW	18W	● 4200 K	1800 lm	220 x 220 x 28 mm	85 - 265 V
CX-S01-18CW	18W	● 6500 K	1800 lm	220 x 220 x 28 mm	85 - 265 V
CX-S01-24WW	24W	● 3000 K	2400 lm	295 x 295 x 28 mm	85 - 265 V
CX-S01-24NW	24W	● 4200 K	2400 lm	295 x 295 x 28 mm	85 - 265 V
CX-S01-24CW	24W	● 6500 K	2400 lm	295 x 295 x 28 mm	85 - 265 V

85-265 V/  
50-60 Hz

ID proizvoda	Snaga	CCT	Lumen	Dimenzije	Napon
CX-S02-6WW	6W	● 3000 K	300 lm	107 x 107 x 40 mm	85 - 265 V
CX-S02-6NW	6W	● 4200 K	300 lm	107 x 107 x 40 mm	85 - 265 V
CX-S02-6CW	6W	● 6500 K	300 lm	107 x 107 x 40 mm	85 - 265 V
CX-S02-12WW	12W	● 3000 K	600 lm	155 x 155 x 40 mm	85 - 265 V
CX-S02-12NW	12W	● 4200 K	600 lm	155 x 155 x 40 mm	85 - 265 V
CX-S02-12CW	12W	● 6500 K	600 lm	155 x 155 x 40 mm	85 - 265 V
CX-S02-18WW	18W	● 3000 K	1200 lm	208 x 208 x 40 mm	85 - 265 V
CX-S02-18NW	18W	● 4200 K	1200 lm	208 x 208 x 40 mm	85 - 265 V
CX-S02-18CW	18W	● 6500 K	1200 lm	208 x 208 x 40 mm	85 - 265 V
CX-S02-24WW	24W	● 3000 K	1800 lm	280 x 280 x 40 mm	85 - 265 V
CX-S02-24NW	24W	● 4200 K	1800 lm	280 x 280 x 40 mm	85 - 265 V
CX-S02-24CW	24W	● 6500 K	1800 lm	280 x 280 x 40 mm	85 - 265 V



## CCT 3 U 1

SLIM  
DIZAJN

IP20

220-240 V/  
50-60 Hz

ID proizvoda	Snaga	CCT	Lumen	Dimenzije	Napon
PL60-40-3CCT	40W	<b>3 U 1</b> 3000 K   4000 K   6500 K	4000 lm	595 x 595 x 9 mm	220 - 240 V



IP44

176-265 V/  
50-60 Hz

ID proizvoda	Snaga	CCT	Lumen	Dimenzije	Napon
PL60-42-WW	42W	3000 K	3780 lm	595 x 595 x 10 mm	176 - 265 V



## CCT 3 U 1



IP40

220-240 V/  
50-60 Hz

ID proizvoda	Snaga	CCT	Lumen	Dimenzije	Napon
PLX6060	40W	<b>3 U 1</b> 3000 K   4000 K   6500 K	5200 lm	595 x 595 x 30 mm	220 - 240 V
PLX6060-25	25W	<b>3 U 1</b> 3000 K   4000 K   6500 K	4000 lm	595 x 595 x 30 mm	220 - 240 V



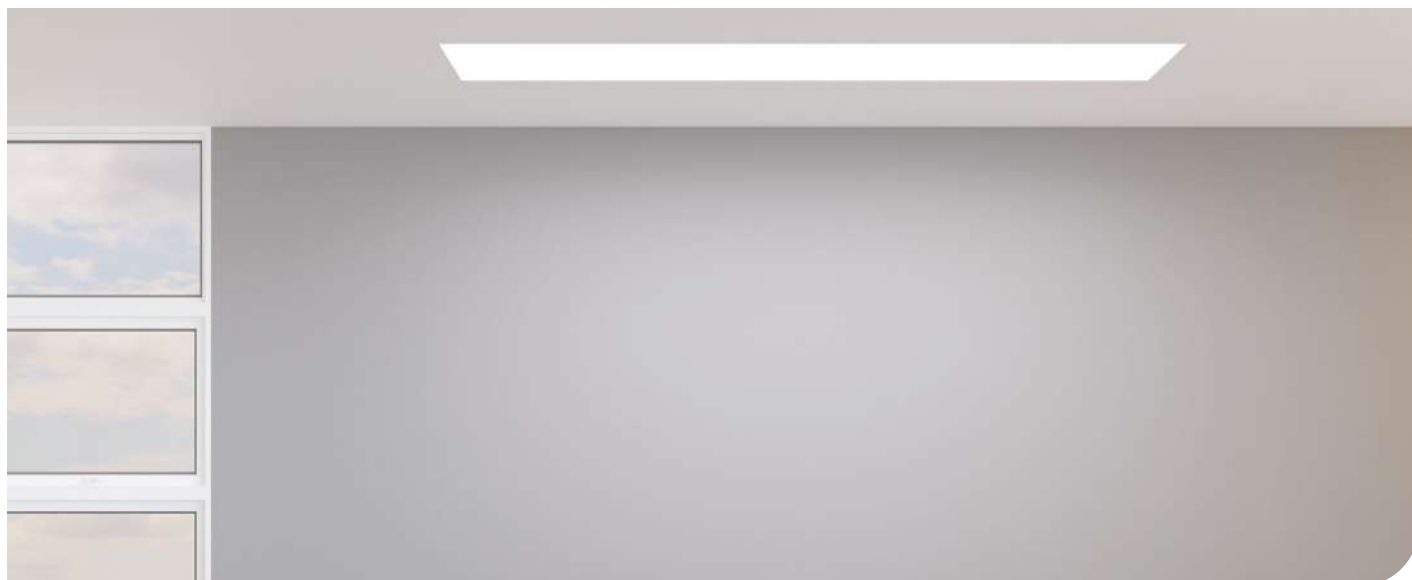

220-240 V/  
50-60 Hz

ID proizvoda	Snaga	CCT	Lumen	Dimenzije	Napon
PLX30120	40W	 <b>3 U 1</b> 3000 K   4000 K   6500 K	5200 lm	295 x 1195 x 30 mm	220 - 240 V



220-240 V/  
50-60 Hz



ID proizvoda	Snaga	CCT	Lumen	Dimenzije	Napon
PLX60120	60W	 <b>3 U 1</b> 3000 K   4000 K   6500 K	7800 lm	595 x 1195 x 30 mm	220 - 240 V

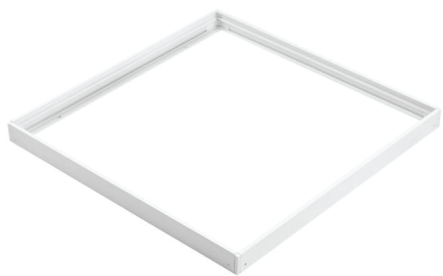

ID proizvoda	Namjena	Dimenzije
LF-0595	Nadgradna montaža	601 x 601 x 42 mm

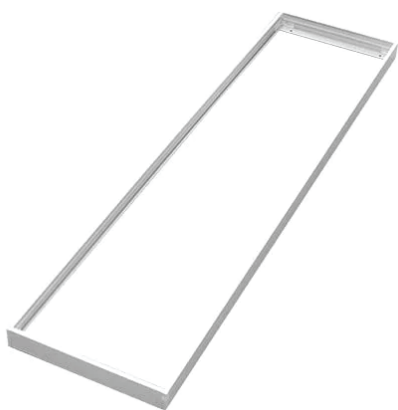

ID proizvoda	Namjena	Dimenzije
LF-1195	Nadgradna montaža	1200 x 300 x 42 mm

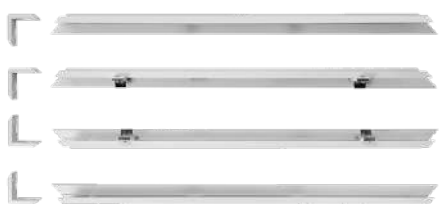

ID proizvoda	Namjena	Dimenzije
LT-0595	Ugradna montaža	648 x 648 x 30 mm



ID proizvoda	Namjena	Dimenzije
LT-1195	Ugradna montaža	1240 x 348 x 29 mm



ID proizvoda	Namjena	Dimenzije
LFD-0595	Nadgradna montaža	601 x 601 x 70 mm

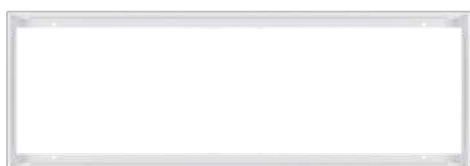

ID proizvoda	Namjena	Dimenzije
LFD-30120	Nadgradna montaža	301 x 1201 x 70 mm

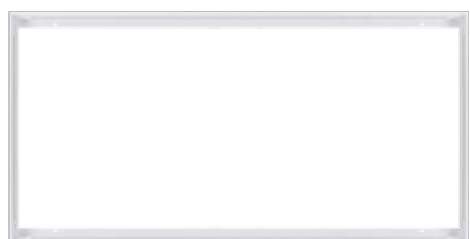

ID proizvoda	Namjena	Dimenzije
LFD-60120	Ugradna montaža	601 x 1201 x 70 mm

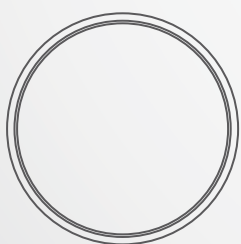

## LED PLAFONJERE

LED plafonjere kombiniraju inovativnu tehnologiju i sofisticiran dizajn kako bi pružile optimalno osvetljenje u svakom prostoru. Karakterizira ih ravnomjerna distribucija svjetlosti, dug vijek trajanja i niska potrošnja energije. S različitim opcijama dizajna i funkcionalnosti, ove plafonjere su prikladne za moderne interijere, nudeći pouzdano i elegantno rješenje za dnevne sobe, spavaće sobe, uredske prostore i hodnike.

220-240 V/  
50-60 Hz

ID proizvoda	Snaga	CCT	Lumen	Dimenzije	Napon
CLD-8903	24W	● 4000 K	2880 lm	Ø 380 x 65 mm	220 - 240 V



ID proizvoda	Snaga	CCT	Lumen	Dimenzije	Napon
CLD-8904	24W	● 4000 K	2880 lm	Ø 390 x 75 mm	220 - 240 V



ID proizvoda	Snaga	CCT	Lumen	Dimenzije	Napon
CLD-8905	36W	● 4000 K	4320 lm	Ø 490 x 60 mm	220 - 240 V

220-240 V/  
50-60 Hz

ID proizvoda	Snaga	CCT	Lumen	Dimenzije	Napon
CLD-8906	24W	● 4000 K	2880 lm	335 x 335 x 55 mm	220 - 240 V
CLD-8907	36W	● 4000 K	4320 lm	485 x 485 x 55 mm	220 - 240 V



ID proizvoda	Snaga	CCT	Lumen	Dimenzije	Napon
CLD-8908	36W	● 4000 K	4320 lm	Ø 510 x 75 mm	220 - 240 V



ID proizvoda	Snaga	CCT	Lumen	Dimenzije	Napon
CLD-8909	24W	● 4000 K	2880 lm	Ø 390 x 80 mm	220 - 240 V





**CCT 3 U 1**

3000K 4500K 6500K



220-240 V/  
50-60 Hz



ID proizvoda	Snaga	CCT	Lumen	Dimenzije	Napon
CLE-36W	36W	 <b>3 U 1</b> 3000 K   4500 K   6500 K	3600 lm	Ø 400 x 42 mm	220 - 240 V
CLE-50W	50W	 <b>3 U 1</b> 3000 K   4500 K   6500 K	5000 lm	Ø 500 x 42 mm	220 - 240 V





**CCT 5 U 1**  
 3000K 3500K 4000K 5000K 6500K



100-240 V/  
50-60 Hz

ID proizvoda	Snaga	CCT	Lumen	Dimenzije	Napon
CNX-18W-BK	18W	 <b>5 U 1</b> 3000 K   3500 K   4000 K   5000K   6500K	1890 lm	Ø 225 x 24 mm	100 - 240 V
CNX-20W-BK	20W	 <b>5 U 1</b> 3000 K   3500 K   4000 K   5000K   6500K	2300 lm	Ø 300 x 24 mm	100 - 240 V
CNX-24W-BK	24W	 <b>5 U 1</b> 3000 K   3500 K   4000 K   5000K   6500K	2520 lm	Ø 400 x 24 mm	100 - 240 V



ID proizvoda	Snaga	CCT	Lumen	Dimenzije	Napon
CNX-18W-WH	18W	 <b>5 U 1</b> 3000 K   3500 K   4000 K   5000K   6500K	1890 lm	Ø 225 x 24 mm	100 - 240 V
CNX-20W-WH	20W	 <b>5 U 1</b> 3000 K   3500 K   4000 K   5000K   6500K	2300 lm	Ø 300 x 24 mm	100 - 240 V
CNX-24W-WH	24W	 <b>5 U 1</b> 3000 K   3500 K   4000 K   5000K   6500K	2520 lm	Ø 400 x 24 mm	100 - 240 V





220 V



ID proizvoda	Snaga	CCT	Lumen	Dimenzije	Napon
CLF-48W-NW	48W	● 4000 K	4800 lm	Ø 450 x 65 mm	220 V

175-240 V/  
50-60 Hz

ID proizvoda	Snaga	CCT	Lumen	Dimenzije	Napon
CLW-032S-18W-3CCT	18W	●●● <b>3 U 1</b> 3000 K   4000 K   6500 K	1620 lm	280 x 280 x 50 mm	175 - 240 V

176-265 V/  
50-60 Hz

ID proizvoda	Snaga	CCT	Lumen	Dimenzije	Napon
CLW-032-18W-NW	18W	● 4000 K	1440 lm	Ø 280 x 50 mm	176 - 265 V
CLW-032-18W-WW	18W	● 3000 K	1440 lm	Ø 280 x 50 mm	176 - 265 V



175-240 V/  
50-60 Hz



ID proizvoda	Snaga	CCT	Lumen	Dimenzije	Napon
CWK-24W-BK	24W	<b>3 U 1</b> 3000 K   4000 K   6500 K	2400 lm	Ø 300 x 55 mm	175 - 240 V



ID proizvoda	Snaga	CCT	Lumen	Dimenzije	Napon
CWK-24W-WH	24W	<b>3 U 1</b> 3000 K   4000 K   6500 K	2400 lm	Ø 300 x 55 mm	175 - 240 V

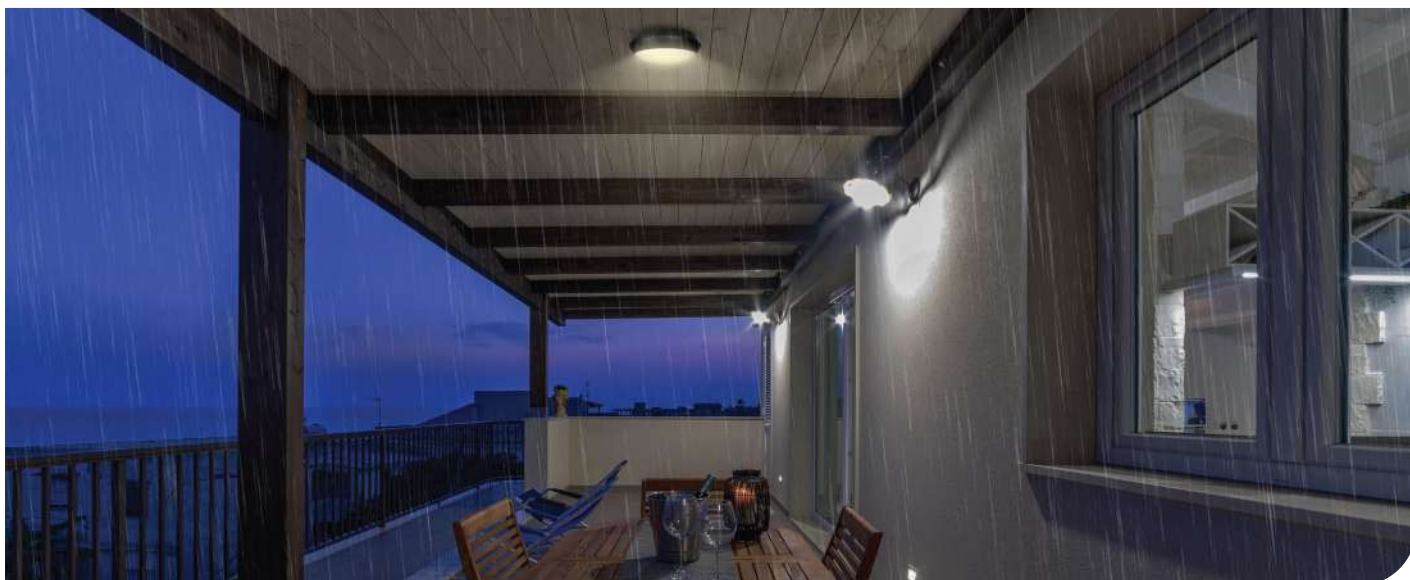

**CCT 3 U 1**

3000K 4000K 6000K



176-265 V/  
50-60 Hz



ID proizvoda	Snaga	CCT	Lumen	Dimenzije	Napon
CLW-022-15W-WH	15W	 <b>3 U 1</b> 3000 K   4000 K   6000 K	1200 lm	Ø 300 x 95 mm	176 - 265 V



ID proizvoda	Snaga	CCT	Lumen	Dimenzije	Napon
CLW-022-15W-BK	15W	 <b>3 U 1</b> 3000 K   4000 K   6000 K	1200 lm	Ø 300 x 95 mm	176 - 265 V

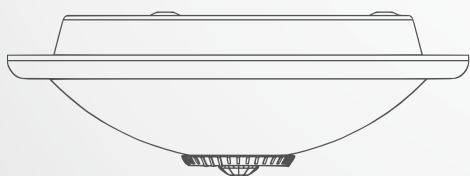

## LED PLAFONJERE SA SENZOROM

Pametno osvetljenje s LED plafonjerama sa senzorom osigurava visoku funkcionalnost i uštedu energije. Zahvaljujući sensorima pokreta ili svjetlosti, ove plafonjere automatski prilagođavaju svoje uključivanje i isključivanje, što ih čini idealnim za hodnike, stubišta, ulazne prostore i druge prometne zone. Moderan dizajn i dugotrajna tehnologija čine ih savršenim izborom za praktično i učinkovito osvetljenje.



**CCT 3 U 1**



220-240 V/  
50-60 Hz



ID proizvoda	Snaga	CCT	Lumen	Dimenzije	Napon
ELS-802	18W	<b>3 U 1</b> 3000 K   4000 K   6000 K	1800 lm	Ø 230,7 x 19 mm	220 - 240 V



110-240 V/  
50-60 Hz



ID proizvoda	Snaga	CCT	Lumen	Dimenzije	Napon
CLS-77B-16W-NW	16W	4000 K	1440 lm	Ø 290 x 60 mm	110 - 240 V

## LED PLAFONJERE SA SENZOROM

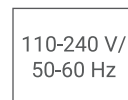

ID proizvoda	Snaga	CCT	Lumen	Dimenzije	Napon
CLS-800-16NW	16W	● 3000 K	≈ 1107 lm	250 x 250 x 57 mm	110 - 240 V

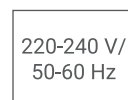

ID proizvoda	Snaga	CCT	Lumen	Dimenzije	Napon
CLS-71B-16W-NW	16W	● 4000 K	1440 lm	Ø 250 x 49 mm	220 - 240 V



ID proizvoda	Snaga	CCT	Lumen	Dimenzije	Napon
CLS-706-12W-NW	12W	● 4000 K	1080 lm	Ø 270 x 68,5 mm	220 - 240 V

## LED PLAFONJERE SA SENZOROM

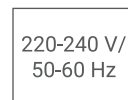

ID proizvoda	Snaga	Tip grla	Dimenzije	Napon
CLS-A78	max. 2 x 40 W	2 x E27	Ø 300 x 96,8 mm	220 - 240 V

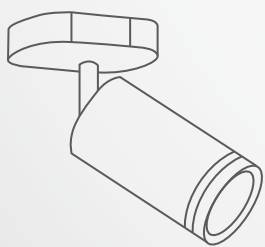

## LED **SPOT SVJETILJKE**

LED spot svjetiljke modernog dizajna, idealne za usmjereno osvjetljenje i isticanje ključnih elemenata u prostoru. S visokom energetsom efikasnošću i dugim vijekom trajanja, ove svjetiljke pružaju optimalno osvjetljenje uz minimalnu potrošnju energije. Diskretne i elegantne, savršene su za stambene i komercijalne prostore, omogućujući fleksibilno i precizno osvjetljenje svakog kutka.





220-240 V/  
50 Hz



ID proizvoda	Snaga	Tip grla	Dimenzije	Napon
FEBA-1	max. 1 x 7 W	1 x GU10	Ø 60 x 85 mm	220 - 240 V



ID proizvoda	Snaga	Tip grla	Dimenzije	Napon
FEBA-2	max. 2 x 7 W	2 x GU10	Ø 60 x 85 mm	220 - 240 V



ID proizvoda	Snaga	Tip grla	Dimenzije	Napon
FEBA-3	max. 3 x 7 W	3 x GU10	Ø 60 x 85 mm	220 - 240 V



220-240 V/  
50 Hz



ID proizvoda	Snaga	Tip grla	Dimenzije	Napon
FEBA-4	max. 4 x 7 W	4 x GU10	Ø 60 x 85 mm	220 - 240 V



ID proizvoda	Snaga	Tip grla	Dimenzije	Napon
ZARA-1	max. 1 x 7 W	1 x GU10	Ø 60 x 85 mm	220 - 240 V



ID proizvoda	Snaga	Tip grla	Dimenzije	Napon
ZARA-2	max. 2 x 7 W	2 x GU10	Ø 60 x 85 mm	220 - 240 V

220-240 V/  
50 Hz

ID proizvoda	Snaga	Tip grla	Dimenzije	Napon
ZARA-3	max. 3 x 7 W	3 x GU10	Ø 60 x 85 mm	220 - 240 V



ID proizvoda	Snaga	Tip grla	Dimenzije	Napon
ZARA-4	max. 4 x 12 W	4 x GU10	Ø 60 x 85 mm	220 - 240 V



ID proizvoda	Snaga	Tip grla	Dimenzije	Napon
LUXA-1	max. 1 x 12 W	1 x GU10	Ø 55 x 110 mm	220 - 240 V



220-240 V/  
50 Hz



ID proizvoda	Snaga	Tip grla	Dimenzije	Napon
LUXA-2	max. 2 x 12 W	2 x GU10	Ø 55 x 110 mm	220 - 240 V



ID proizvoda	Snaga	Tip grla	Dimenzije	Napon
LUXA-3	max. 3 x 12 W	3 x GU10	Ø 55 x 110 mm	220 - 240 V



ID proizvoda	Snaga	Tip grla	Dimenzije	Napon
LUXA-4	max. 4 x 12 W	4 x GU10	Ø 55 x 110 mm	220 - 240 V





220-240 V/  
50 Hz



ID proizvoda	Snaga	Tip grla	Dimenzije	Napon
NYXA-1	max. 1 x 12 W	1 x GU10	Ø 55 x 110 mm	220 - 240 V



ID proizvoda	Snaga	Tip grla	Dimenzije	Napon
NYXA-2	max. 2 x 12 W	2 x GU10	Ø 55 x 110 mm	220 - 240 V



ID proizvoda	Snaga	Tip grla	Dimenzije	Napon
NYXA-3	max. 3 x 12 W	3 x GU10	Ø 55 x 110 mm	220 - 240 V

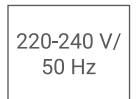

ID proizvoda	Snaga	Tip grla	Dimenzije	Napon
NYXA-4	max. 4 x 12 W	4 x GU10	Ø 55 x 110 mm	220 - 240 V

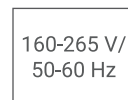

ID proizvoda	Snaga	Tip grla	Dimenzije	Napon
B031-BK	max. 30 W	GU10	Ø 53 x 100 mm	160 - 265 V



ID proizvoda	Snaga	Tip grla	Dimenzije	Napon
B031-WH	max. 30 W	GU10	Ø 53 x 100 mm	160 - 265 V



ID proizvoda	Snaga	Tip grla	Dimenzije	Napon
B0311-BK	max. 30 W	GU10	Ø 55 x 150 mm	160 - 265 V





ID proizvoda	Snaga	Tip grla	Dimenzije	Napon
B0311-WH	max. 30 W	GU10	Ø 55 x 150 mm	160 - 265 V



ID proizvoda	Snaga	Tip grla	Dimenzije	Napon
B033-BK	max. 30 W	GU10	Ø 75 x 135 mm	160 - 265 V



ID proizvoda	Snaga	Tip grla	Dimenzije	Napon
B033-WH	max. 30 W	GU10	Ø 75 x 135 mm	160 - 265 V

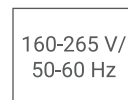

ID proizvoda	Snaga	Tip grla	Dimenzije	Napon
M39S-BK	max. 30 W	GU10	60 x 60 x 100 mm	160 - 265 V



ID proizvoda	Snaga	Tip grla	Dimenzije	Napon
M39S-WH	max. 30 W	GU10	60 x 60 x 100 mm	160 - 265 V



ID proizvoda	Snaga	Tip grla	Dimenzije	Napon
T155M-BK	max. 7 W	GU10	Ø 90 x 100 mm	220 - 240 V



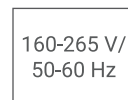

ID proizvoda	Snaga	Tip grla	Dimenzije	Napon
T155M-WH	max. 7 W	GU10	Ø 90 x 100 mm	220 - 240 V



ID proizvoda	Snaga	Tip grla	Dimenzije	Napon
T156M-BK	max. 7 W	GU10	Ø 68 x 100 mm	220 - 240 V



ID proizvoda	Snaga	Tip grla	Dimenzije	Napon
T156M-WH	max. 7 W	GU10	Ø 68 x 100 mm	220 - 240 V



220-240 V/  
50 Hz

ID proizvoda

Snaga

Tip grla

Dimenzije

Napon

TS116-BK

max. 7 W

GU10

Ø 96 x 125 mm

220 - 240 V



ID proizvoda

Snaga

Tip grla

Dimenzije

Napon

TS116-WH

max. 7 W

GU10

Ø 96 x 125 mm

220 - 240 V

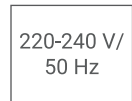

ID proizvoda	Snaga	Tip grla	Dimenzije	Napon
TS117-BK	max. 7 W	GU10	Ø 80 x 84 mm	220 - 240 V



ID proizvoda	Snaga	Tip grla	Dimenzije	Napon
TS117-WH	max. 7 W	GU10	Ø 80 x 84 mm	220 - 240 V



ID proizvoda	Snaga	Tip grla	Dimenzije	Napon
YS084S-BK	max. 12 W	GU10	80 x 80 x 84 mm	220 - 240 V

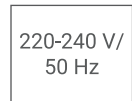

ID proizvoda	Snaga	Tip grla	Dimenzije	Napon
YS084S-WH	max. 12 W	GU10	80 x 80 x 84 mm	220 - 240 V



ID proizvoda	Snaga	Tip grla	Dimenzije	Napon
YS125S-BK	max. 12 W	GU10	96 x 96 x 125 mm	220 - 240 V



ID proizvoda	Snaga	Tip grla	Dimenzije	Napon
YS125S-WH	max. 12 W	GU10	96 x 96 x 125 mm	220 - 240 V

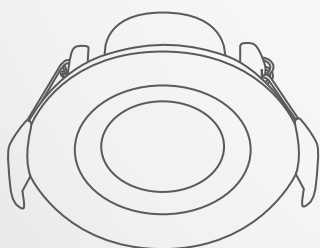

## LED DOWNLIGHT

LED downlighti pružaju diskretno i učinkovito osvjetljenje, savršeno za poslovne i industrijske prostore. Njihov moderan dizajn omogućava lako uklapanje u svaki interijer, dok LED tehnologija osigurava nisku potrošnju energije i dug vijek trajanja. Idealni su za ravnomjerno osvjetljavanje prostora s visokim standardima energetske učinkovitosti.





85-265 V/  
50-60 Hz

ID proizvoda	Snaga	CCT	Lumen	Dimenzije	Napon
DW-R03-6W-3CCT	6W	 <b>3 U 1</b> 3000 K   4000 K   6500 K	360 lm	Ø 90 x 50 mm	85 - 265 V
DW-R03-12W-3CCT	12W	 <b>3 U 1</b> 3000 K   4000 K   6500 K	840 lm	Ø 120 x 50 mm	85 - 265 V
DW-R03-22W-3CCT	22W	 <b>3 U 1</b> 3000 K   4000 K   6500 K	1760 lm	Ø 170 x 50 mm	85 - 265 V

CCT 3 U 1

PRO  
S E R I E S

IP20

85-265 V/  
50-60 Hz

ID proizvoda	Snaga	CCT	Lumen	Dimenzije	Napon
DW-S02-2W-3CCT	2W	<b>3 U 1</b> 3000 K   4000 K   6500 K	60 lm	42 x 41 x 32 mm	85 - 265 V



ID proizvoda	Snaga	CCT	Lumen	Dimenzije	Napon
DW-S02-10W-3CCT	10W	<b>3 U 1</b> 3000 K   4000 K   6500 K	700 lm	144 x 41 x 32 mm	85 - 265 V



ID proizvoda	Snaga	CCT	Lumen	Dimenzije	Napon
DW-S02-20W-3CCT	20W	<b>3 U 1</b> 3000 K   4000 K   6500 K	1400 lm	276 x 41 x 32 mm	85 - 265 V



ID proizvoda	Snaga	CCT	Lumen	Dimenzije	Napon
DW-S02-30W-3CCT	30W	<b>3 U 1</b> 3000 K   4000 K   6500 K	2100 lm	409 x 41 x 32 mm	85 - 265 V

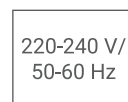

ID proizvoda	Snaga	CCT	Lumen	Dimenzije	Napon
DWE-20W	20W	 <b>3 U 1</b> 3000 K   4000 K   5700 K	1800 lm	Ø 174 x 87 mm	220 - 240 V
DWE-28W	28W	 <b>3 U 1</b> 3000 K   4000 K   5700 K	2520 lm	Ø 232 x 110 mm	220 - 240 V
DWE-40W	40W	 <b>3 U 1</b> 3000 K   4000 K   5700 K	3600 lm	Ø 280 x 130 mm	220 - 240 V



100-240 V/  
50-60 Hz



ID proizvoda	Snaga	CCT	Lumen	Dimenzije	Napon
DWX-3WH	3W	 <b>3 U 1</b> 3000 K   4000 K   6500 K	240 lm	Ø 70 x 34 mm	100 - 240 V
DWX-5WH	5W	 <b>3 U 1</b> 3000 K   4000 K   6500 K	400 lm	Ø 85 x 39 mm	100 - 240 V
DWX-9WH	9W	 <b>3 U 1</b> 3000 K   4000 K   6500 K	800 lm	Ø 112 x 40 mm	100 - 240 V



ID proizvoda	Snaga	CCT	Lumen	Dimenzije	Napon
DWX-3BK	3W	 <b>3 U 1</b> 3000 K   4000 K   6500 K	240 lm	Ø 70 x 34 mm	100 - 240 V
DWX-5BK	5W	 <b>3 U 1</b> 3000 K   4000 K   6500 K	400 lm	Ø 85 x 39 mm	100 - 240 V
DWX-9BK	9W	 <b>3 U 1</b> 3000 K   4000 K   6500 K	800 lm	Ø 112 x 40 mm	100 - 240 V

## LED DOWNLIGHT

---



85-265 V/  
50-60 Hz



ID proizvoda	Snaga	CCT	Lumen	Dimenzije	Napon
DL-5W-NW	5W	● 4000 K	500 lm	Ø 92 x 40 mm	85 - 265 V

---

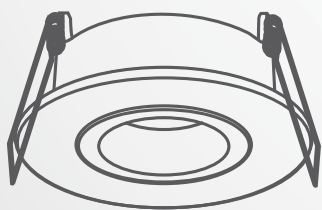

## ROZETNE

Rozetne pružaju stabilno i estetski ugodno rješenje za ugradnju rasvjete. Ove diskretne i funkcionalne komponente omogućavaju sigurno postavljanje LED žarulja, uz moderan i minimalistički dizajn koji se lako uklapa u svaki prostor. Idealne su za stropnu ugradnju, pružajući pouzdano osvjetljenje uz jednostavnu instalaciju.



ID proizvoda	Snaga	Tip grla	Dimenzije
DWC-R1B	max. 7 W	GU10	Ø 85 x 39 mm



ID proizvoda	Snaga	Tip grla	Dimenzije
DWC-R1W	max. 7 W	GU10	Ø 85 x 35 mm



ID proizvoda	Snaga	Tip grla	Dimenzije
DWC-S1W	max. 7 W	GU10	85 x 85 x 40 mm

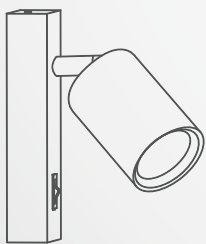

## ZIDNE LAMPE

Zidne lampe nude elegantno i praktično rješenje za osvjetljenje vašeg doma ili poslovnog prostora. S različitim stilovima i dizajnima, savršeno se uklapaju u svaki interijer, dodajući ambijentalno osvjetljenje i stvarajući ugodnu atmosferu. Idealne su za hodnike, spavaće sobe, dnevne boravke ili kao dodatna rasvjeta u radnim prostorima.



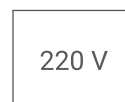

ID proizvoda	Snaga	CCT	Lumen	Dimenzije	Napon
B8070-6W-WW	6W	● 3000 K	660 lm	200 x 80 x 95 mm	220 V



ID proizvoda	Snaga	CCT	Lumen	Dimenzije	Napon
B8071-6W-WW	6W	● 3000 K	660 lm	200 x 80 x 95 mm	220 V



220-240 V/  
50-60 Hz

ID proizvoda	Snaga	CCT	Lumen	Dimenzije	Napon
LH-013-3W-WW	3W	● 3000 K	150 lm	25 x 60 (280) mm	220 - 240 V



ID proizvoda	Snaga	CCT	Lumen	Dimenzije	Napon
WL-3W-WW-BK	3W	● 3000 K	180 lm	25 x 110 mm	220 - 240 V

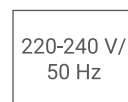

ID proizvoda	Snaga	Tip grla	Dimenzije	Napon
TS194-BK	max. 7 W	GU10	Ø 55 x 110 mm	220 - 240 V



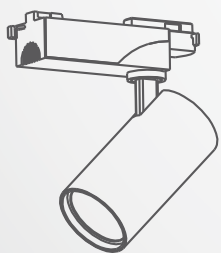

ID proizvoda	Snaga	Tip grla	Dimenzije	Napon
TS194-WH	max. 7 W	GU10	Ø 55 x 110 mm	220 - 240 V

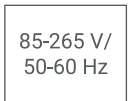

## ŠINSKA RASVJETA

Šinska rasvjeta pruža fleksibilno i prilagodljivo rješenje za osvjetljenje različitih prostora. Ove svjetiljke montirane na šine omogućuju usmjereno osvjetljenje koje se lako može prilagoditi prema potrebama. Idealna je za poslovne prostore, galerije i moderne interijere, nudeći energetske učinkovitu i dugotrajnu rasvjetu s mogućnošću preciznog podešavanja svjetlosnih izvora.



ID proizvoda	Snaga	CCT	Lumen	Dimenzije	Napon
L068-10W-3CCT-BK	10W	 <b>3 U 1</b> 3000 K   4000 K   6500 K	900 lm	Ø 50 x 100 mm	85 - 265 V
L068-20W-3CCT-BK	20W	 <b>3 U 1</b> 3000 K   4000 K   6500 K	1800 lm	Ø 60 x 135 mm	85 - 265 V
L068-30W-3CCT-BK	30W	 <b>3 U 1</b> 3000 K   4000 K   6500 K	2700 lm	Ø 80 x 150 mm	85 - 265 V



ID proizvoda	Snaga	CCT	Lumen	Dimenzije	Napon
L068-10W-3CCT-WH	10W	 <b>3 U 1</b> 3000 K   4000 K   6500 K	900 lm	Ø 50 x 100 mm	85 - 265 V
L068-20W-3CCT-WH	20W	 <b>3 U 1</b> 3000 K   4000 K   6500 K	1800 lm	Ø 60 x 135 mm	85 - 265 V
L068-30W-3CCT-WH	30W	 <b>3 U 1</b> 3000 K   4000 K   6500 K	2700 lm	Ø 80 x 150 mm	85 - 265 V

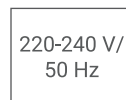

ID proizvoda	Snaga	Tip grla	Dimenzije	Napon
L194-BK	max. 7 W	GU10	Ø 55 x 100 mm	220 - 240 V



ID proizvoda	Snaga	Tip grla	Dimenzije	Napon
L194-WH	max. 7 W	GU10	Ø 55 x 100 mm	220 - 240 V



ID proizvoda	Snaga	Tip grla	Dimenzije	Napon
L100-BK	max. 7 W	GU10	Ø 60 x 200 mm	220 - 240 V





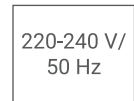

ID proizvoda	Snaga	Tip grla	Dimenzije	Napon
L100-WH	max. 7 W	GU10	Ø 60 x 200 mm	220 - 240 V



ID proizvoda	Snaga	Tip grla	Dimenzije	Napon
L200-BK	max. 7 W	GU10	Ø 55 x 80 mm	220 - 240 V



ID proizvoda	Snaga	Tip grla	Dimenzije	Napon
L200-WH	max. 7 W	GU10	Ø 55 x 80 mm	220 - 240 V



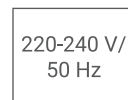

ID proizvoda	Snaga	Tip grla	Dimenzije	Napon
L300-BK	max. 7 W	GU10	Ø 53 x 100 mm	220 - 240 V



ID proizvoda	Snaga	Tip grla	Dimenzije	Napon
L300-WH	max. 7 W	GU10	Ø 53 x 100 mm	220 - 240 V



ID proizvoda	Materijal	Dimenzije
FI01-BK	Aluminij	78 x 28 x 19 mm



ID proizvoda	Materijal	Dimenzije
FI01-WH	Aluminij	78 x 28 x 19 mm



ID proizvoda	Materijal	Dimenzije
FL01-BK	Aluminij	70 x 70 x 19 mm



ID proizvoda	Materijal	Dimenzije
FL01-WH	Aluminij	70 x 70 x 19 mm



ID proizvoda	Materijal	Dimenzije
FLEX01-BK	Aluminij	260 x 35 x 19 mm



ID proizvoda	Materijal	Dimenzije
FLEX01-WH	Aluminij	260 x 35 x 19 mm



ID proizvoda	Materijal	Dimenzije
FT01-BK	Aluminij	105 x 70 x 19 mm



ID proizvoda	Materijal	Dimenzije
FT01-WH	Aluminij	105 x 70 x 19 mm



ID proizvoda	Materijal	Dimenzije
FX01-BK	Aluminij	105 x 105 x 19 mm



ID proizvoda	Materijal	Dimenzije
FX01-WH	Aluminij	105 x 105 x 19 mm

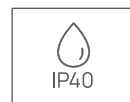

160-265 V/  
50 Hz



ID proizvoda	Materijal	Dimenzije
FWA02-1-BK	Aluminij	1000 x 33 x 21 mm
FWA02-2-BK	Aluminij	2000 x 33 x 21 mm



ID proizvoda	Materijal	Dimenzije
FWA02-1-WH	Aluminij	1000 x 33 x 21 mm
FWA02-2-WH	Aluminij	2000 x 33 x 21 mm



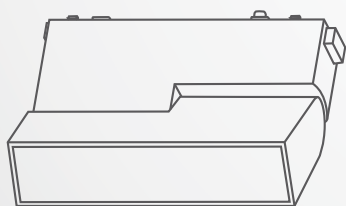

## MAGNETNA ŠINSKA RASVJETA

Magnetna šinska rasvjeta nudi inovativno i elegantno rješenje za osvetljenje, uz maksimalnu fleksibilnost. Svjetiljke se lako postavljaju i pomiču zahvaljujući magnetskom sustavu, omogućujući brzo prilagođavanje osvetljenja prema potrebama prostora. S modernim dizajnom i niskom potrošnjom energije, idealna je za poslovne prostore, galerije i suvremene interijere gdje je potrebna preciznost i funkcionalnost.



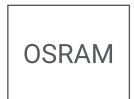
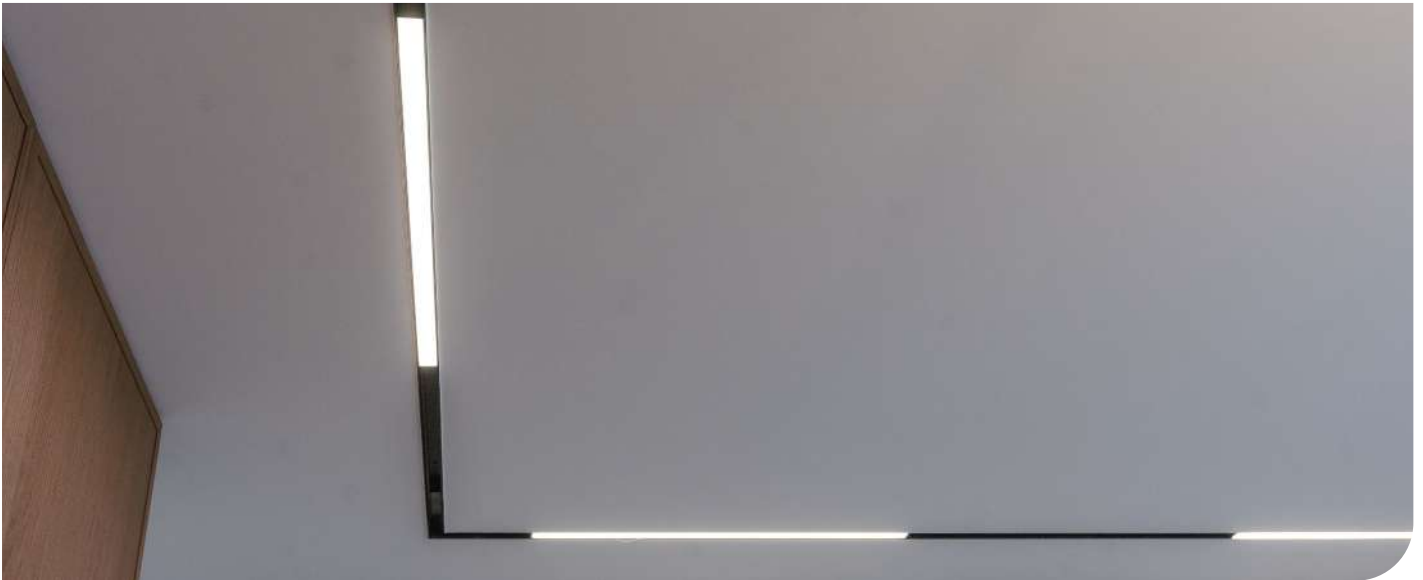

ID proizvoda	Snaga	CCT	Lumen	Dimenzije	Napon
MT01-20-10W-3CCT	10W	<b>3 U 1</b> 3000 K   4000 K   6500 K	≥ 700 lm	307 x 22 x 25 mm	DC 48 V
MT01-20-20W-3CCT	20W	<b>3 U 1</b> 3000 K   4000 K   6500 K	≥ 1400 lm	607 x 22 x 25 mm	DC 48 V
MT01-20-30W-3CCT	30W	<b>3 U 1</b> 3000 K   4000 K   6500 K	≥ 2100 lm	907 x 22 x 25 mm	DC 48 V

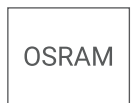

ID proizvoda	Snaga	CCT	Lumen	Dimenzije	Napon
MT02-20-6W-3CCT	6W	<b>3 U 1</b> 3000 K   4000 K   6500 K	≥ 420 lm	115 x 22 x 25 mm	DC 48 V
MT02-20-12W-3CCT	12W	<b>3 U 1</b> 3000 K   4000 K   6500 K	≥ 840 lm	223 x 22 x 25 mm	DC 48 V
MT02-20-18W-3CCT	18W	<b>3 U 1</b> 3000 K   4000 K   6500 K	≥ 1260 lm	331 x 22 x 25 mm	DC 48 V
MT02-20-24W-3CCT	24W	<b>3 U 1</b> 3000 K   4000 K   6500 K	≥ 1680 lm	439 x 22 x 25 mm	DC 48 V

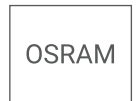

ID proizvoda	Snaga	CCT	Lumen	Dimenzije	Napon
MT03-20-6W-3CCT	6W	<b>3 U 1</b> 3000 K   4000 K   6500 K	≥ 420 lm	110 x 22 x 80 mm	DC 48 V
MT03-20-12W-3CCT	12W	<b>3 U 1</b> 3000 K   4000 K   6500 K	≥ 840 lm	220 x 22 x 80 mm	DC 48 V



ID proizvoda	Snaga	CCT	Lumen	Dimenzije	Napon
MT05-20-6W-3CCT	6W	<b>3 U 1</b> 3000 K   4000 K   6500 K	≥ 420 lm	110 x 22 x 80 mm	DC 48 V
MT05-20-12W-3CCT	12W	<b>3 U 1</b> 3000 K   4000 K   6500 K	≥ 840 lm	220 x 22 x 80 mm	DC 48 V



ID proizvoda	Snaga	CCT	Lumen	Dimenzije	Napon
MT08-20-10W-3CCT	10W	<b>3 U 1</b> 3000 K   4000 K   6500 K	≥ 900 lm	Ø 48 x 105 mm	DC 48 V
MT08-20-20W-3CCT	20W	<b>3 U 1</b> 3000 K   4000 K   6500 K	≥ 1800 lm	Ø 58 x 155 mm	DC 48 V







ID proizvoda	Raspon upravljanja	Napon
MT-SP019	20 m ~ 30 m	DC 3 V



ID proizvoda	Materijal	Dimenzije
MT-TR201-1M	Aluminij	1000 x 61,9 x 46,2 mm
MT-TR201-2M	Aluminij	2000 x 61,9 x 46,2 mm



ID proizvoda	Materijal	Dimenzije
MT-TR203-1M	Aluminij	1000 x 25,85 x 52,2 mm
MT-TR203-2M	Aluminij	2000 x 25,85 x 52,2 mm



ID proizvoda	Snaga	Napon
MT-SP008	100W	AC 220 V / DC 48 V



ID proizvoda	Snaga	Napon
MT-SP009	200W	AC 220 V / DC 48 V



ID proizvoda	Materijal	Napon
MT-SP010	Bakar + PC	AC 220 V / DC 48 V



ID proizvoda	Materijal	Napon
MT-SP011	Bakar + PC	AC 220 V / DC 48 V



ID proizvoda	Materijal	Napon
MT-SP012	Bakar + PC	AC 220 V / DC 48 V



ID proizvoda	Materijal	Napon
MT-SP013	SS	/



ID proizvoda	Materijal	Dimenzije
MT-SP015	Aluminij	100 x 100 mm



ID proizvoda	Materijal	Dimenzije
MT-SP016	Aluminij	100 x 100 mm



ID proizvoda	Snaga	Napon
MT-SP018	200W	AC 220 V / DC 48 V



ID proizvoda	Materijal	Dimenzije
MT-SP001	Aluminij	100 x 100 mm



ID proizvoda	Materijal	Dimenzije
MT-SP002	Aluminij	100 x 100 mm



ID proizvoda	Materijal	Dimenzije
MT-SP006	PLA	26 x 52,5 mm



ID proizvoda	Materijal	Dimenzije
MT-SP007	PLA	30 x 50 mm



**CCT 3 U 1**

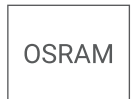

ID proizvoda	Snaga	CCT	Lumen	Dimenzije	Napon
MG01-6W-3CCT	6W	<b>3 U 1</b> 3000 K   4000 K   6500 K	≥ 370 lm	122 x 26 x 24 mm	DC 48 V
MG01-12W-3CCT	12W	<b>3 U 1</b> 3000 K   4000 K   6500 K	≥ 700 lm	230 x 26 x 24 mm	DC 48 V
MG01-18W-3CCT	18W	<b>3 U 1</b> 3000 K   4000 K   6500 K	≥ 1100 lm	338 x 26 x 24 mm	DC 48 V
MG01-24W-3CCT	24W	<b>3 U 1</b> 3000 K   4000 K   6500 K	≥ 1520 lm	445 x 26 x 24 mm	DC 48 V



**CCT 3 U 1**

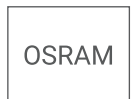

ID proizvoda	Snaga	CCT	Lumen	Dimenzije	Napon
MG02-6W-3CCT	6W	<b>3 U 1</b> 3000 K   4000 K   6500 K	≥ 510 lm	122 x 26 x 24 mm	DC 48 V
MG02-12W-3CCT	12W	<b>3 U 1</b> 3000 K   4000 K   6500 K	≥ 1000 lm	230 x 26 x 24 mm	DC 48 V
MG02-18W-3CCT	18W	<b>3 U 1</b> 3000 K   4000 K   6500 K	≥ 1540 lm	338 x 26 x 24 mm	DC 48 V





**CCT 3 U 1**

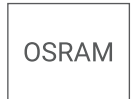

ID proizvoda	Snaga	CCT	Lumen	Dimenzije	Napon
MG03-6W-3CCT	6W	<b>3 U 1</b> 3000 K   4000 K   6500 K	≥ 370 lm	122 x 26 x 80 mm	DC 48 V
MG03-12W-3CCT	12W	<b>3 U 1</b> 3000 K   4000 K   6500 K	≥ 700 lm	230 x 26 x 80 mm	DC 48 V



ID proizvoda	Snaga	CCT	Lumen	Dimenzije	Napon
MG04-6W-3CCT	6W	<b>3 U 1</b> 3000 K   4000 K   6500 K	≥ 510 lm	122 x 26 x 80 mm	DC 48 V
MG04-12W-3CCT	12W	<b>3 U 1</b> 3000 K   4000 K   6500 K	≥ 1000 lm	230 x 26 x 80 mm	DC 48 V



ID proizvoda	Snaga	CCT	Lumen	Dimenzije	Napon
MG05-6W-3CCT	6W	<b>3 U 1</b> 3000 K   4000 K   6500 K	≥ 370 lm	122 x 26 x 80 mm	DC 48 V
MG05-12W-3CCT	12W	<b>3 U 1</b> 3000 K   4000 K   6500 K	≥ 700 lm	230 x 26 x 80 mm	DC 48 V





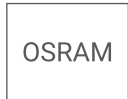

ID proizvoda	Snaga	CCT	Lumen	Dimenzije	Napon
MG06-6W-3CCT	6W	 <b>3 U 1</b> 3000 K   4000 K   6500 K	≥ 510 lm	122 x 26 x 80 mm	DC 48 V
MG06-12W-3CCT	12W	 <b>3 U 1</b> 3000 K   4000 K   6500 K	≥ 1000 lm	230 x 26 x 80 mm	DC 48 V



ID proizvoda	Snaga	CCT	Lumen	Dimenzije	Napon
MG07-3W-3CCT	3W	 <b>3 U 1</b> 3000 K   4000 K   6500 K	≥ 270 lm	Ø 35 x 80 mm	DC 48 V
MG07-6W-3CCT	6W	 <b>3 U 1</b> 3000 K   4000 K   6500 K	≥ 540 lm	Ø 42 x 100 mm	DC 48 V
MG07-10W-3CCT	10W	 <b>3 U 1</b> 3000 K   4000 K   6500 K	≥ 700 lm	Ø 48 x 105 mm	DC 48 V
MG07-20W-3CCT	20W	 <b>3 U 1</b> 3000 K   4000 K   6500 K	≥ 1650 lm	Ø 58 x 130 mm	DC 48 V
MG07-30W-3CCT	30W	 <b>3 U 1</b> 3000 K   4000 K   6500 K	≥ 2010 lm	Ø 68 x 155 mm	DC 48 V



ID proizvoda	Snaga	CCT	Lumen	Dimenzije	Napon
MG09-6W-3CCT	9W	 <b>3 U 1</b> 3000 K   4000 K   6500 K	≥ 330 lm	122 x 26 x 55 mm	DC 48 V



CCT 3 U 1



ID proizvoda	Snaga	CCT	Lumen	Dimenzije	Napon
MG10-6W-3CCT	6W	 <b>3 U 1</b> 3000 K   4000 K   6500 K	≥ 510 lm	Ø 75 x 75 mm	DC 48 V





ID proizvoda	Snaga	CCT	Lumen	Dimenzije	Napon
MG11-9W-3CCT	9W	 <b>3 U 1</b> 3000 K   4000 K   6500 K	≥ 550 lm	Ø 95 x 30 mm	DC 48 V



ID proizvoda	Snaga	CCT	Lumen	Dimenzije	Napon
MG14-6W-3CCT	6W	 <b>3 U 1</b> 3000 K   4000 K   6500 K	≥ 350 lm	100 x 100 mm	DC 48 V

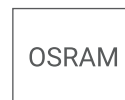



ID proizvoda	Snaga	CCT	Lumen	Dimenzije	Napon
MG15-6W-3CCT	6W	 <b>3 U 1</b> 3000 K   4000 K   6500 K	≥ 350 lm	100 x 100 mm	DC 48 V



ID proizvoda	Snaga	CCT	Lumen	Dimenzije	Napon
MG16-6W-3CCT	6W	 <b>3 U 1</b> 3000 K   4000 K   6500 K	≥ 510 lm	Ø 30 x 300 mm	DC 48 V



ID proizvoda	Snaga	CCT	Lumen	Dimenzije	Napon
MG17-6W-3CCT	6W	 <b>3 U 1</b> 3000 K   4000 K   6500 K	≥ 510 lm	150 x 150 mm	DC 48 V



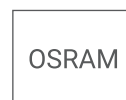
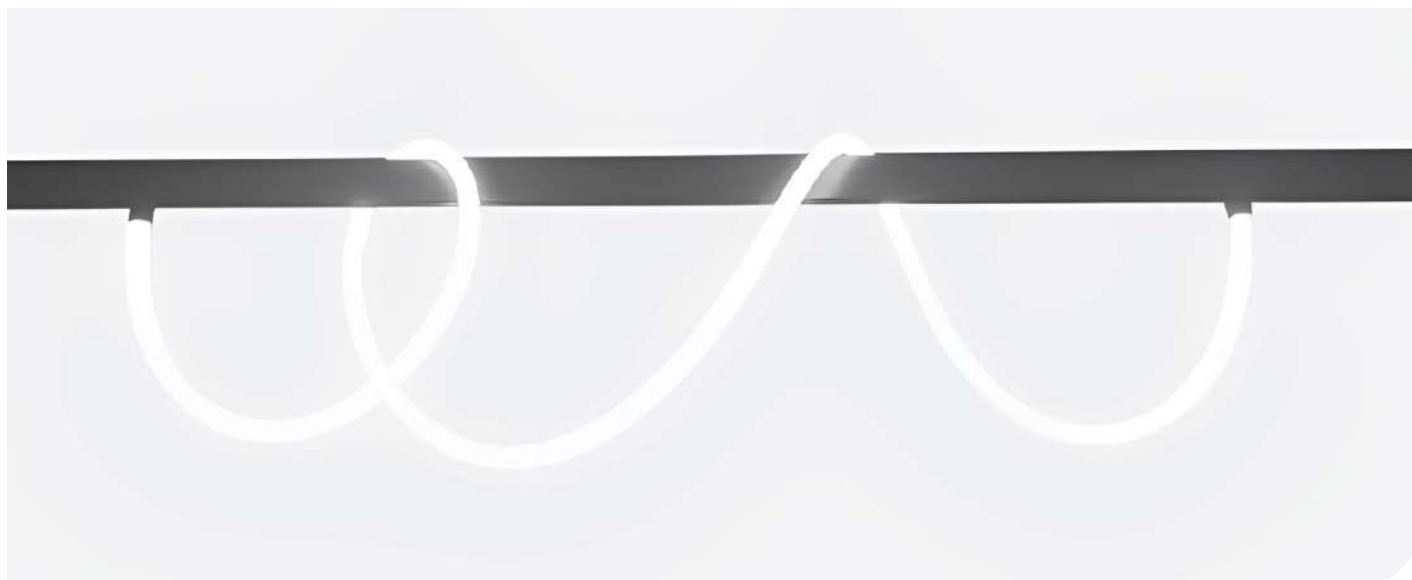

ID proizvoda	Snaga	CCT	Lumen	Dimenzije	Napon
MG19-32W-NW	32W	● 4000 K	≥ 1950 lm	Ø 22 x 2000 mm	DC 48 V
MG19-32W-WW	32W	● 3000 K	≥ 1950 lm	Ø 22 x 2000 mm	DC 48 V
MG19-48W-NW	48W	● 4000 K	≥ 3100 lm	Ø 22 x 3000 mm	DC 48 V
MG19-48W-WW	48W	● 3000 K	≥ 3100 lm	Ø 22 x 3000 mm	DC 48 V
MG19-64W-NW	12W	● 4000 K	≥ 4100 lm	Ø 22 x 4000 mm	DC 48 V
MG19-64W-WW	12W	● 3000 K	≥ 4100 lm	Ø 22 x 4000 mm	DC 48 V
MG19-80W-NW	18W	● 4000 K	≥ 4600 lm	Ø 22 x 5000 mm	DC 48 V
MG19-80W-WW	18W	● 3000 K	≥ 4600 lm	Ø 22 x 5000 mm	DC 48 V





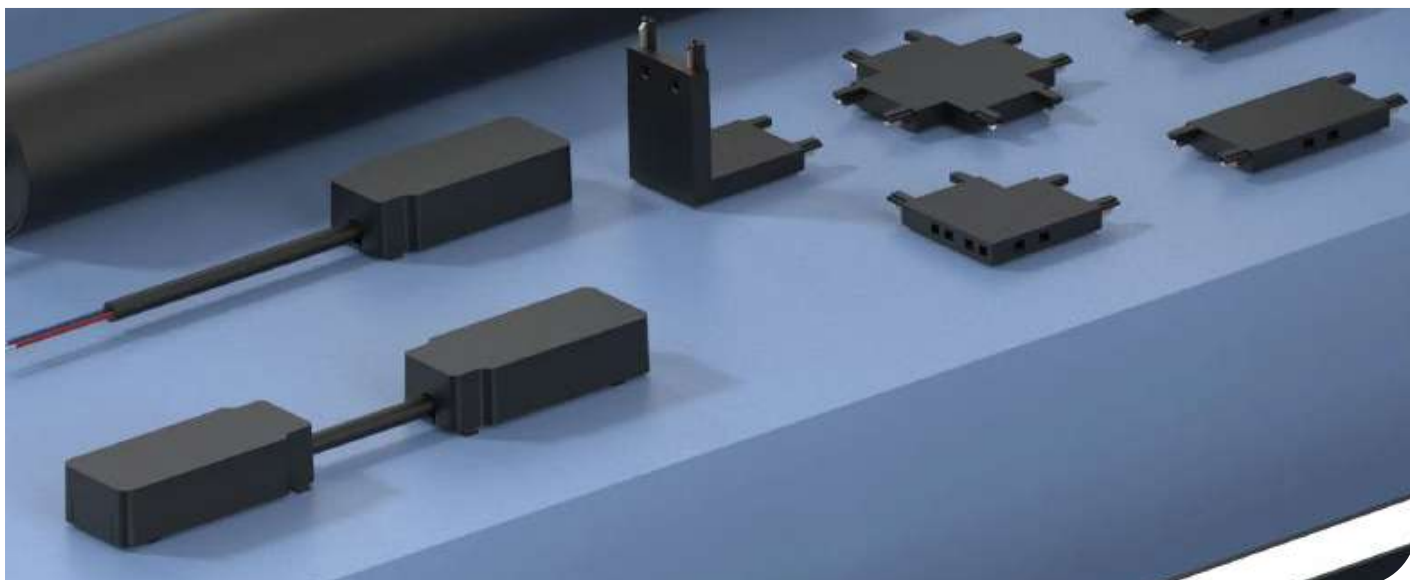

AC 220 V /  
DC 48 V



ID proizvoda	Snaga	Struja
MG-D200W-SC	200W	4.1 A
MG-D200W-TM-3CCT	200W	4.7 A

\* MG-D200W-SC

Jedna boja - odgovara za magnetne svjetiljke pod šifrom MG19

\* MG-D200W-TM-3CCT

3 CCT - odgovara za magnetne svjetiljke sa 3 boje svjetlosti iz MG serije

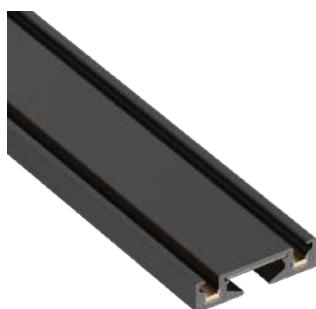

ID proizvoda	Materijal	Dimenzije
MG-TR01-1M	Aluminij	1000 x 26 x 6,3 mm
MG-TR01-2M	Aluminij	2000 x 26 x 6,3 mm
MG-TR01-3M	Aluminij	3000 x 26 x 6,3 mm







ID proizvoda	Materijal	Dimenzije
MG-SP01	PC	100 x 26 x 29 mm



ID proizvoda	Materijal	Dimenzije
MG-SP02	PC + bakar	270 x 26 x 15 mm

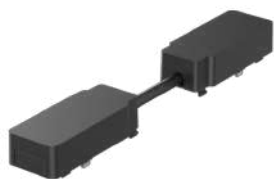

ID proizvoda	Materijal	Dimenzije
MG-SP03	PC + bakar	150 x 26 x 15 mm

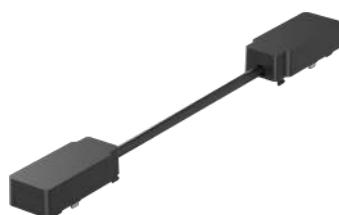

ID proizvoda	Materijal	Dimenzije
MG-SP04	PC + bakar	300 x 26 x 15 mm



ID proizvoda	Materijal	Dimenzije
MG-TR01-1	PC + bakar	25 x 25 x 26 mm



ID proizvoda	Materijal	Dimenzije
MG-TR01-2	PC + bakar	59 x 26 x 6 mm

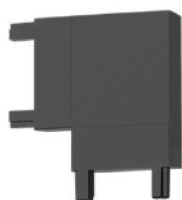

ID proizvoda	Materijal	Dimenzije
MG-TR01-3	PC + bakar	43 x 43 x 6 mm



ID proizvoda	Materijal	Dimenzije
MG-TR01-4	PC + bakar	59 x 43 x 6 mm

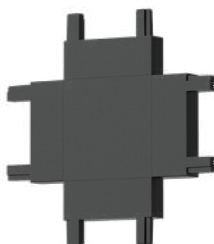

ID proizvoda	Materijal	Dimenzije
MG-TR01-5	PC + bakar	59 x 59 x 6 mm



## LED KUPAONSKE LAMPE

LED kupaonske lampe pružaju snažno i pouzdano osvetljenje, idealno za vlažne prostore poput kupaonica. Dizajnirane s fokusom na otpornost prema vlazi i dugotrajnost, osiguravaju sigurnu upotrebu i energetski učinkovitu rasvjetu. Svojim modernim dizajnom i ravnomjernim svjetlom doprinose estetskom izgledu kupaonice, pružajući ugodnu atmosferu i optimalnu funkcionalnost.



220-240 V/  
50-60 Hz



ID proizvoda	Snaga	CCT	Lumen	Dimenzije	Napon
BTM-400	8W	● 4000 K	560 lm	400 x 128 x 51 mm	220 - 240 V
BTM-600	12W	● 4000 K	840 lm	600 x 128 x 51 mm	220 - 240 V
BTM-800	15W	● 4000 K	1050 lm	800 x 128 x 51 mm	220 - 240 V



230 V/  
50 Hz

ID proizvoda

Snaga

CCT

Lumen

Dimenzije

Napon

BTS-600

15W

● 4000 K

1350 lm

400 x 128 x 51 mm

230 V





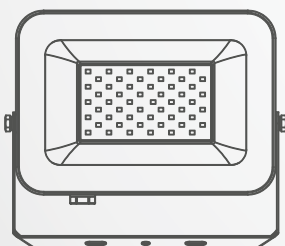

## LED REFLEKTORI

LED reflektori pružaju snažno i usmjereno osvjetljenje, idealno za vanjske i industrijske prostore. Zahvaljujući visokoj energetskej učinkovitosti i dugotrajnosti, omogućuju pouzdano osvjetljenje velikih površina uz minimalne troškove održavanja. S robusnim dizajnom otpornim na vremenske uvjete, savršeni su za osvjetljavanje dvorišta, skladišta, parkirališta i drugih prostora kojima je potrebna moćna rasvjeta.

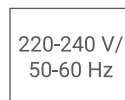

ID proizvoda	Snaga	CCT	Lumen	Dimenzije	Napon
AFS-10BK	10W	● 6500K	900 lm	111 x 148 x 55 mm	220 - 240 V
AFS-20BK	20W	● 6500K	1700 lm	132 x 169 x 55 mm	220 - 240 V
AFS-30BK	30W	● 6500K	2550 lm	168 x 196 x 50 mm	220 - 240 V
AFS-50BK	50W	● 6500K	4250 lm	205 x 214 x 50 mm	220 - 240 V



ID proizvoda	Snaga	CCT	Lumen	Dimenzije	Napon
AFS-10WH	10W	● 6500K	900 lm	111 x 148 x 55 mm	220 - 240 V
AFS-20WH	20W	● 6500K	1700 lm	132 x 169 x 55 mm	220 - 240 V
AFS-30WH	30W	● 6500K	2550 lm	168 x 196 x 50 mm	220 - 240 V
AFS-50WH	50W	● 6500K	4250 lm	205 x 214 x 50 mm	220 - 240 V

220-240 V/  
50-60 Hz

ID proizvoda	Snaga	CCT	Lumen	Dimenzije	Napon
ALX-10BK	10W	● 6500K	900 lm	111 x 98 x 21 mm	220 - 240 V
ALX-20BK	20W	● 6500K	1700 lm	132 x 121 x 21 mm	220 - 240 V
ALX-30BK	30W	● 6500K	2550 lm	168 x 157 x 22 mm	220 - 240 V
ALX-50BK	50W	● 6500K	4250 lm	205 x 170 x 22 mm	220 - 240 V
ALX-100BK	100W	● 6500K	8500 lm	295 x 246 x 30 mm	220 - 240 V



ID proizvoda	Snaga	CCT	Lumen	Dimenzije	Napon
ALX-10WH	10W	● 6500K	900 lm	111 x 98 x 21 mm	220 - 240 V
ALX-20WH	20W	● 6500K	1700 lm	132 x 121 x 21 mm	220 - 240 V
ALX-30WH	30W	● 6500K	2550 lm	168 x 157 x 22 mm	220 - 240 V
ALX-50WH	50W	● 6500K	4250 lm	205 x 170 x 22 mm	220 - 240 V
ALX-100WH	100W	● 6500K	8500 lm	295 x 246 x 30 mm	220 - 240 V



## CCT 3 U 1

185-265 V/  
50-60 Hz

ID proizvoda	Snaga	CCT	Lumen	Dimenzije	Napon
S3X-30W-3CCT	30W	<b>3 U 1</b> 3000 K   4000 K   6500 K	3500 lm	207 x 176 x 38 mm	185 - 265 V
S3X-50W-3CCT	50W	<b>3 U 1</b> 3000 K   4000 K   6500 K	4900 lm	237 x 210 x 38 mm	185 - 265 V
S3X-100W-3CCT	100W	<b>3 U 1</b> 3000 K   4000 K   6500 K	11300 lm	327 x 268 x 48 mm	185 - 265 V
S3X-150W-3CCT	150W	<b>3 U 1</b> 3000 K   4000 K   6500 K	16000 lm	370 x 310 x 49 mm	185 - 265 V
S3X-200W-3CCT	200W	<b>3 U 1</b> 3000 K   4000 K   6500 K	19900 lm	414 x 343 x 52 mm	185 - 265 V

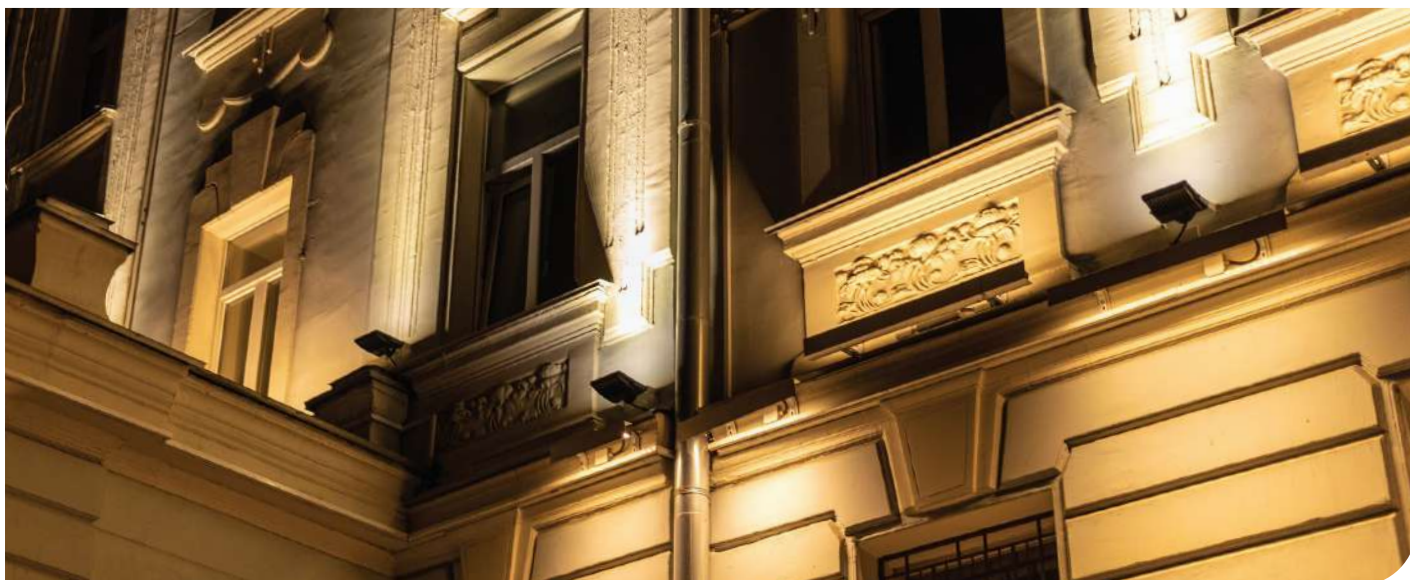

**PRO**  
SERIES

MEANWELL  
DRIVER

IP66

100-277 V/  
50-60 Hz

ID proizvoda	Snaga	CCT	Lumen	Dimenzije	Napon
PREMIUM100	100W	● 4200K	15000 lm	278 x 52 x 369 mm	100 - 277 V
PREMIUM200	200W	● 4200K	30000 lm	392 x 57 x 445 mm	100 - 277 V
PREMIUM300	300W	● 4200K	45000 lm	392 x 59 x 497 mm	100 - 277 V
PREMIUM400	400W	● 4200K	60000 lm	205 x 214 x 50 mm	100 - 277 V



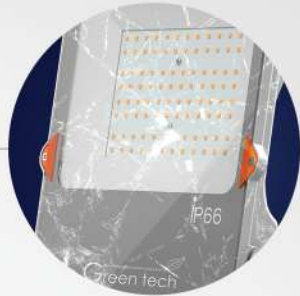

**PREMIUM serija**

# LED REFLEKTORI



220-240 V/  
50-60 Hz

ID proizvoda	Snaga	CCT	Lumen	Dimenzije	Napon
MXX-50-CW	50W	● 6000 K	5500 lm	235 x 205 x 135 mm	220 - 240 V



5 V / 2 A

ID proizvoda	Snaga	CCT	Lumen	Dimenzije	Napon
WLR40	40W	● 4000 K	500 lm	220 x 196 x 230 mm	5 V / 2 A
WLR60	60W	● 4000 K	800 lm	220 x 196 x 230 mm	5 V / 2 A



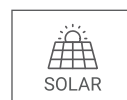

ID proizvoda	Snaga	CCT	Lumen	Dimenzije reflektora	Tip baterije
SLF-25W-CW	25W	● 6500K	399 lm	193 x 155 x 47 mm	3.2 V, 5000 mAh
SLF-40W-CW	40W	● 6500K	621 lm	230 x 195 x 50 mm	3.2 V, 5000 mAh
SLF-60W-CW	60W	● 6500K	1095 lm	263 x 220 x 64 mm	3.2 V, 10000 mAh
SLF-100W-CW	100W	● 6500K	1486 lm	313 x 263 x 72 mm	3.2 V, 15000 mAh
SLF-200W-CW	200W	● 6500K	1882 lm	350 x 277 x 74 mm	3.2 V, 20000 mAh

## LED REFLEKTORI

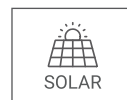

ID proizvoda	Snaga	CCT	Lumen	Dimenzije reflektora	Tip baterije
VENUS-S	2W	● 4000 K	200 lm	119 x 30 x 74 mm	18650, 1800 mAh
VENUS-M	12W	● 4000 K	1500 lm	119 x 30 x 74 mm	18650, 3000 mAh

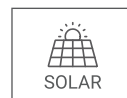

ID proizvoda	Snaga	CCT	Lumen	Dimenzije reflektora	Tip baterije
VENUS-L	5W	● 4000 K	500 lm	135 x 85 x 50 mm	18650, 1200 mAh



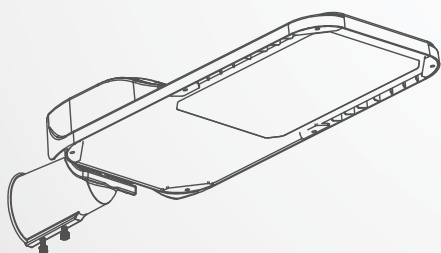

## LED CESTOVNA RASVJETA

LED cestovna rasvjeta osigurava visoku vidljivost i sigurnost na prometnicama uz nisku potrošnju energije. Dizajnirana za pouzdan rad u svim vremenskim uvjetima, pruža ravnomjerno i snažno osvjetljenje koje smanjuje odsjaj i povećava sigurnost za vozače i pješake. Zahvaljujući dugotrajnosti i malim troškovima održavanja, idealno je rješenje za moderne prometnice i javne površine.



ID proizvoda	Snaga	CCT	Lumen	Dimenzije	Napon
STL-30	30W	● 6000 K	2400 lm	355 x 125 mm	220 V
STL-50	50W	● 6000 K	4000 lm	405 x 165 mm	220 V

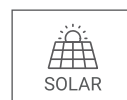

ID proizvoda	Snaga	CCT	Lumen	Dimenzije	Tip baterije
SLD-100W-CW	100W	● 6000 K	2000 lm	218 x 492 mm	4 x 5.5 Ah 3.2 V



ID proizvoda	Snaga	CCT	Lumen	Dimenzije	Tip baterije
SLX-60W-CW	60W	● 6000 K	1200 lm	250 x 650 x 65 mm	4 x 5.5 Ah 3.2 V
SLX-80W-CW	80W	● 6000 K	1600 lm	300 x 730 x 65 mm	4 x 5.5 Ah 3.2 V





**CCT 3 U 1**

3000K 4000K 6000K



100-277 V



ID proizvoda	Snaga	CCT	Lumen	Dimenzije	Napon
S10B-30W	30W	 <b>3 U 1</b> 3000 K   4000 K   6000 K	3900 lm	514 x 200 x 84 mm	100 - 277 V
S10B-50W	50W	 <b>3 U 1</b> 3000 K   4000 K   6000 K	6500 lm	514 x 200 x 84 mm	100 - 277 V
S10B-100W	100W	 <b>3 U 1</b> 3000 K   4000 K   6000 K	13000 lm	565 x 220 x 84 mm	100 - 277 V
S10B-150W	150W	 <b>3 U 1</b> 3000 K   4000 K   6000 K	19500 lm	634 x 240 x 84 mm	100 - 277 V





CCT 3 U 1

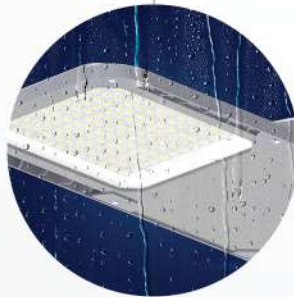
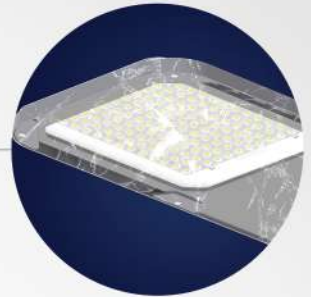

S10B serija

# LED ULIČNE SVJETILJKE

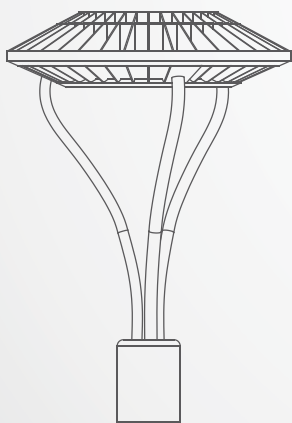

## CESTOVNI I PARKOVSKI **STUBOVI**

Cestovni i parkovski stubovi ključni su elementi vanjske rasvjete koji osiguravaju stabilnost i pouzdanost na otvorenim prostorima. Izrađeni od izdržljivih materijala i otporni na vremenske uvjete, ovi stubovi idealni su za ugradnju rasvjete u parkovima, šetnicama i uz cestovne prometnice. Njihov dizajn doprinosi sigurnosti i estetskoj uređenosti svakog urbanog i zelenog okruženja.



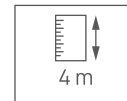

85-265 V/  
50-60 Hz



ID proizvoda	Snaga	CCT	Lumen	Dimenzije	Napon
GT-UL0052-36W	36W	● 4000 K + ● zelena	4680 lm	250 x 200 mm; 4 m	85 - 265 V

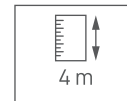

ID proizvoda	Snaga	CCT	Lumen	Dimenzije	Napon
GT-UL0012-30W	30W	● 4000 K + ● zelena	4500 lm	220 x 220 mm; 4 m	85 - 265 V



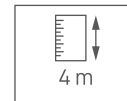

85-265 V/  
50-60 Hz



ID proizvoda	Snaga	CCT	Lumen	Dimenzije	Napon
GT-UL002C3	2 x 30W	● 4000 K + ● zelena	2 x 4500 lm	230 x 230 mm; 4 m	85 - 265 V

Mogućnost odabira boje  
svjetlosti LED trake po  
želji kupca

4000 K

+

RGB

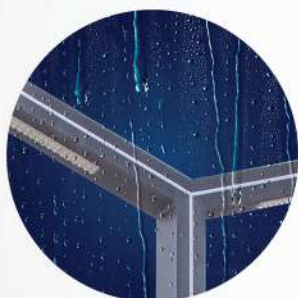

IP65



PHILIPS LED

**GT-UL002C3**

# LED ULIČNA SVJETILJKA

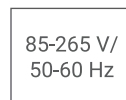
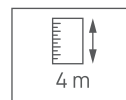

ID proizvoda	Snaga	CCT	Lumen	Dimenzije	Napon
GT-UL1022Y-30W	30W	● 4000 K + ● zelena	4500 lm	250 x 250 mm ; 4 m	85 - 265 V
GT-UL102Y-30W	30W	● 6000 K + ● zelena	4500 lm	200 x 200 mm ; 4 m	85 - 265 V

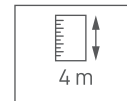

85-265 V/  
50-60 Hz



ID proizvoda	Snaga	CCT	Lumen	Dimenzije	Napon
GT-UL103K3	30W	● 3000 K	4500 lm	250 x 250 mm; 4 m	85 - 265 V

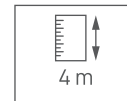

85-265 V/  
50-60 Hz



ID proizvoda	Snaga	CCT	Lumen	Dimenzije	Napon
GT-UL103K4	30W	● 3000 K	4500 lm	250 x 250 mm; 4 m	85 - 265 V



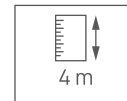

85-265 V/  
50-60 Hz

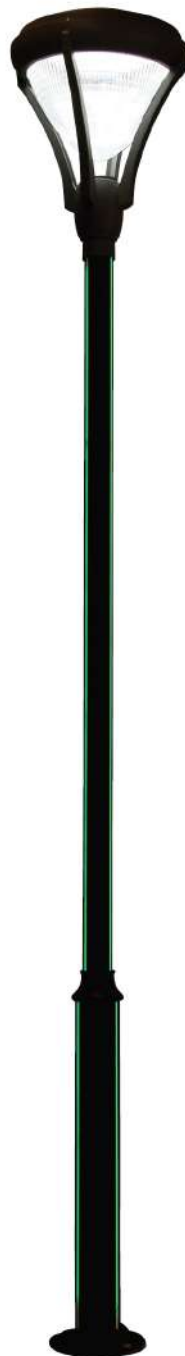

ID proizvoda	Snaga	CCT	Lumen	Dimenzije	Napon
GT-UL103K5	30W	● 3000 K	4500 lm	250 x 250 mm; 4 m	85 - 265 V

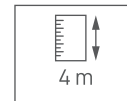

85-265 V/  
50-60 Hz



ID proizvoda	Snaga	CCT	Lumen	Dimenzije	Napon
GT-UL103K9	30W	● 3000 K	4500 lm	250 x 250 mm; 4 m	85 - 265 V

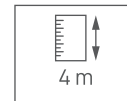

85-265 V/  
50-60 Hz



ID proizvoda	Snaga	CCT	Lumen	Dimenzije	Napon
GT-UL126-30W	30W	● 4000 K	4500 lm	300 x 180 mm; 4 m	85 - 265 V

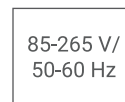
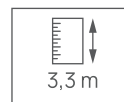
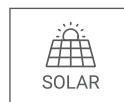

ID proizvoda	Snaga	CCT	Lumen	Dimenzije	Tip baterije
GT-UL129S-30W	30W	● 3000 K	4500 lm	250 x 200 mm; 3,3 m	litijaska 50 AH



**GT-UL129S-30W**

# LED SOLARNA ULIČNA SVJETILJKA



120-277 V/  
50-60 Hz

ID proizvoda	Snaga	CCT	Lumen	Dimenzije	Napon
GLS-X23	80W	<b>3 U 1</b> 3000 K   4000 K   5000 K	135 lm / W	Ø 450 x 650 mm	120 - 277 V

\* Podesiva snaga LED svjetiljke 25 W / 40 W / 60 W / 80 W

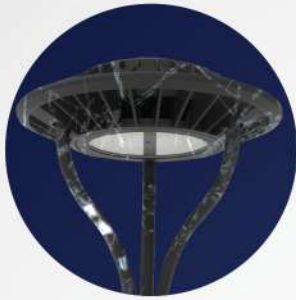

**GLS-X23**

# LED ULIČNA SVJETILJKA

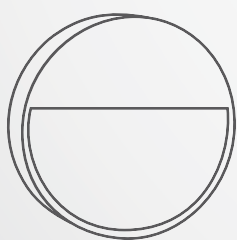

## **VANJSKA ZIDNA RASVJETA**

Vanjska zidna rasvjeta pruža funkcionalno i dekorativno osvjetljenje za eksterijere, ističući arhitektonske detalje i osiguravajući sigurnost oko kuće ili zgrade. Dizajnirana da izdrži različite vremenske uvjete, ova rasvjeta savršeno upotpunjuje ulaze, terase i dvorišta, stvarajući ugodan i privlačan ambijent u vanjskom prostoru.



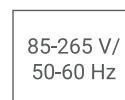

ID proizvoda	Snaga	Tip grla	Dimenzije	Napon
ARVADA	max. 10 W	GU10	63 x 75 x 80 mm	85 - 265 V



ID proizvoda	Snaga	Tip grla	Dimenzije	Napon
CLOVIS	max. 10 W	GU10	67 x 80 x 80 mm	85 - 265 V



ID proizvoda	Snaga	Tip grla	Dimenzije	Napon
DALLAS	max. 2 x 10 W	2 x GU10	62 x 150 x 80 mm	85 - 265 V



ID proizvoda	Snaga	Tip grla	Dimenzije	Napon
MADISON	max. 2 x 10 W	2 x GU10	68 x 150 x 80 mm	85 - 265 V

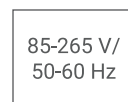

ID proizvoda	Snaga	Tip grla	Dimenzije	Napon
AB2741	max. 60 W	E27	80 x 160 x 110 mm	85 - 265 V



85-265 V/  
50-60 Hz

ID proizvoda	Snaga	CCT	Lumen	Dimenzije	Napon
AB2801	6W	● 3000 K	600 lm	Ø 150 x 50 mm	85 - 265 V



ID proizvoda	Snaga	CCT	Lumen	Dimenzije	Napon
AB2802	12W	● 3000 K	1200 lm	180 x 180 x 45 mm	85 - 265 V



85-265 V/  
50-60 Hz

ID proizvoda	Snaga	CCT	Lumen	Dimenzije	Napon
AB2811	6W	● 3000 K	600 lm	200 x 110 x 30 mm	85 - 265 V



ID proizvoda	Snaga	CCT	Lumen	Dimenzije	Napon
AB2812	12W	● 3000 K	1200 lm	160 x 160 x 40 mm	85 - 265 V



85-265 V/  
50-60 Hz

ID proizvoda	Snaga	CCT	Lumen	Dimenzije	Napon
AB2881	12W	● 3000 K	1200 lm	Ø 160 x 100 mm	85 - 265 V



ID proizvoda	Snaga	CCT	Lumen	Dimenzije	Napon
AB2882	6W	● 3000 K	600 lm	Ø 110 x 85 mm	85 - 265 V



85-265 V/  
50-60 Hz

ID proizvoda	Snaga	CCT	Lumen	Dimenzije	Napon
AB2883	12W	● 3000 K	1200 lm	153 x 153 x 100 mm	85 - 265 V



ID proizvoda	Snaga	CCT	Lumen	Dimenzije	Napon
AB2884	12W	● 3000 K	1200 lm	160 x 160 x 100 mm	85 - 265 V

85-265 V/  
50-60 Hz

ID proizvoda	Snaga	CCT	Lumen	Dimenzije	Napon
AB2891	5W	● 3000 K	500 lm	150 x 165 x 110 mm	85 - 265 V



ID proizvoda	Snaga	CCT	Lumen	Dimenzije	Napon
AB2902	6W	● 3000 K	600 lm	135 x 230 x 45 mm	85 - 265 V



ID proizvoda	Snaga	CCT	Lumen	Dimenzije	Napon
AB2912	6W	● 3000 K	600 lm	150 x 100 x 50 mm	85 - 265 V



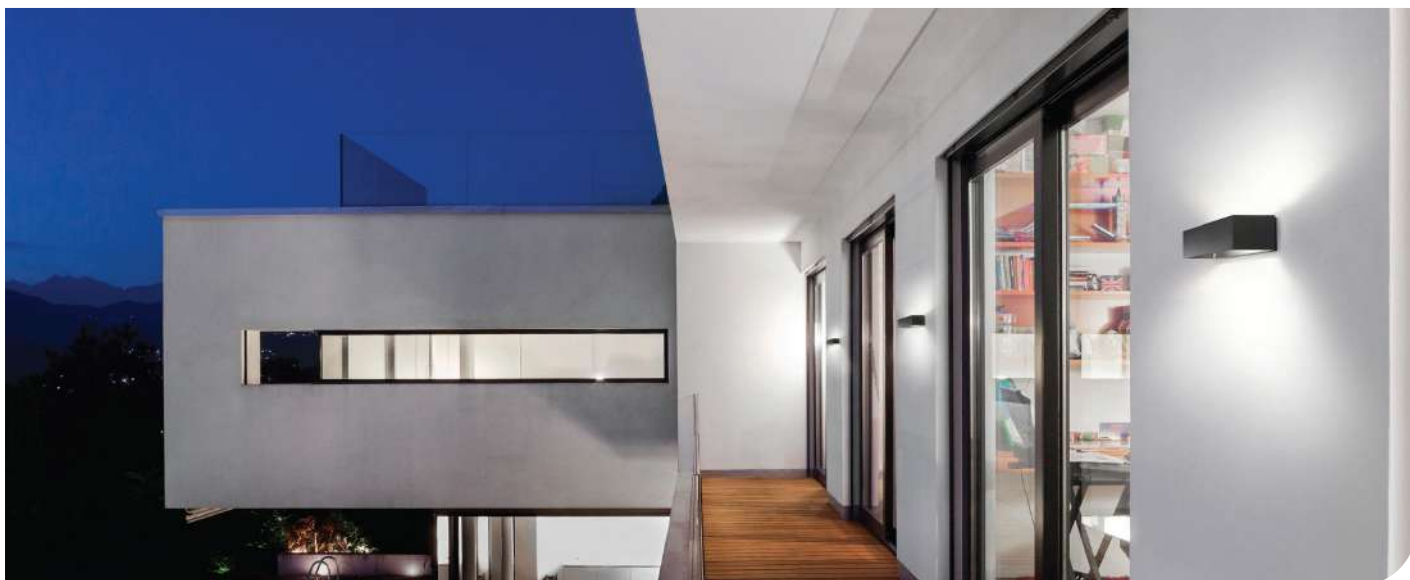

ID proizvoda	Snaga	CCT	Lumen	Dimenzije	Napon
B8070-6W-WW	6W	● 3000 K	660 lm	200 x 80 x 95 mm	220 V



ID proizvoda	Snaga	CCT	Lumen	Dimenzije	Napon
B8071-6W-WW	6W	● 3000 K	660 lm	200 x 80 x 95 mm	220 V



85-265 V/  
50-60 Hz

ID proizvoda	Snaga	CCT	Lumen	Dimenzije	Napon
B8990-10W-WW	10W	● 3000 K	1200 lm	100 x 200 x 80 mm	85 - 265 V



ID proizvoda	Snaga	CCT	Lumen	Dimenzije	Napon
B8991-10W-WW	10W	● 3000 K	1200 lm	100 x 200 x 80 mm	85 - 265 V

85-265 V/  
50-60 Hz

ID proizvoda	Snaga	CCT	Lumen	Dimenzije	Napon
CHARLOTTE	12W	● 3000 K	1320 lm	200 x 290 x 75 mm	85 - 265 V



ID proizvoda	Snaga	CCT	Lumen	Dimenzije	Napon
COLUMBUS	12W	● 3000 K	1320 lm	200 x 290 x 75 mm	85 - 265 V

85-265 V/  
50-60 Hz

ID proizvoda	Snaga	CCT	Lumen	Dimenzije	Napon
CLARA	12W	● 3000 K	960 lm	200 x 200 x 45 mm	85 - 265 V

220-240 V/  
50-60 Hz

ID proizvoda	Snaga	CCT	Lumen	Dimenzije	Napon
CWA-042	11W	● 4000 K	935 lm	Ø 170 x 60 mm	220 - 240 V



ID proizvoda	Snaga	CCT	Lumen	Dimenzije	Napon
CWA-043	11W	● 4000 K	935 lm	Ø 170 x 68 mm	220 - 240 V



ID proizvoda	Snaga	CCT	Lumen	Dimenzije	Napon
CWA-044	11W	● 4000 K	935 lm	Ø 170 x 64 mm	220 - 240 V



85-265 V/  
50-60 Hz

ID proizvoda	Snaga	CCT	Lumen	Dimenzije	Napon
VIRGINIA	12W	● 3000 K	960 lm	Ø 200 x 45 mm	85 - 265 V



ID proizvoda	Snaga	CCT	Lumen	Dimenzije	Napon
KFB-1111	3W	● 3000 K	300 lm	150 x 150 x 35 mm	85 - 265 V

85-265 V/  
50-60 Hz

ID proizvoda	Snaga	CCT	Lumen	Dimenzije	Napon
KFB-1113	3W	● 3000 K	300 lm	150 x 150 x 35 mm	85 - 265 V



ID proizvoda	Snaga	CCT	Lumen	Dimenzije	Napon
KFB-2271	5W	● 3000 K	500 lm	90 x 105 x 85 mm	85 - 265 V



ID proizvoda	Snaga	CCT	Lumen	Dimenzije	Napon
KFB-2272	2 x 5W	● 3000 K	2 x 400 lm	115 x 130 x 90 mm	85 - 265 V



85-265 V/  
50-60 Hz

ID proizvoda	Snaga	CCT	Lumen	Dimenzije	Napon
KFB-350	10W	● 3000 K	1000 lm	210 x 135 x 170 mm	85 - 265 V



ID proizvoda	Snaga	CCT	Lumen	Dimenzije	Napon
KFB-6002	15W	● 3000 K	1500 lm	200 x 160 x 45 mm	85 - 265 V



85-265 V/  
50-60 Hz

ID proizvoda	Snaga	CCT	Lumen	Dimenzije	Napon
KFB-8620	7W	● 3000 K	700 lm	180 x 190 x 70 mm	85 - 265 V



ID proizvoda	Snaga	CCT	Lumen	Dimenzije	Napon
KFB-8872	12W	● 3000 K	1200 lm	240 x 130 x 80 mm	85 - 265 V



85-265 V/  
50-60 Hz

ID proizvoda	Snaga	CCT	Lumen	Dimenzije	Napon
J6006-3W-WW	3W	● 3000 K	360 lm	110 x 45 mm	85 - 265 V



ID proizvoda	Snaga	CCT	Lumen	Dimenzije	Napon
J6018-3W-WW	3W	● 3000 K	360 lm	145 x 70 x 52 mm	85 - 265 V



ID proizvoda	Snaga	CCT	Lumen	Dimenzije	Napon
JF01S-1W-WW	1W	● 3000 K	120 lm	57 x 57 x 50 mm	85 - 265 V
JF01L-2W-WW	2W	● 3000 K	240 lm	82 x 82 x 47 mm	85 - 265 V

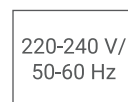

ID proizvoda	Snaga	CCT	Lumen	Dimenzije	Napon
KFS-053S	15W	● 3000 K	1117 lm	66 x 188 x 250 mm	220 - 240 V

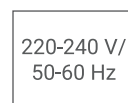

ID proizvoda	Snaga	CCT	Lumen	Dimenzije	Napon
KFS-054	15W	● 4000 K	1099 lm	66 x 188 x 250 mm	220 - 240 V

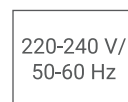

ID proizvoda	Snaga	CCT	Lumen	Dimenzije	Napon
KFS-055	15W	● 3000 K	1079 lm	88 x 53,5 x 231,5 mm	220 - 240 V



ID proizvoda	Snaga	CCT	Lumen	Dimenzije	Napon
KFS-056	20W	● 3000 K	1600 lm	100 x 148 x 244 mm	220 - 240 V

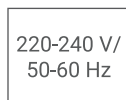

ID proizvoda	Snaga	CCT	Lumen	Dimenzije	Napon
KFS-070	15W	● 3000 K	1050 lm	180 x 210 x 150 mm	220 - 240 V



ID proizvoda	Snaga	CCT	Lumen	Dimenzije	Napon
KFS-071	15W	● 3000 K	1527 lm	180 x 210 x 150 mm	220 - 240 V



ID proizvoda	Snaga	CCT	Lumen	Dimenzije	Napon
KFS-072	25W	● 3000 K	1917 lm	273 x 83,5 x 150 mm	220 - 240 V

VANJSKA ZIDNA RASVJETA

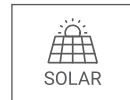

ID proizvoda	Snaga	CCT	Solarni panel	Dimenzije	Tip baterije
SLS-141S	2.2W	● 3000 K	5 V amorphous	188 x 147 x 68 mm	Litijska 3.7 V 1500 mAh

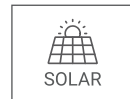

ID proizvoda	Snaga	CCT	Lumen	Dimenzije	Tip baterije
SLS-150S	3.5W	● 6500 K	500 lm	160 x 130 x 28 mm	3.2 V LiFePO4, 1800 mAh

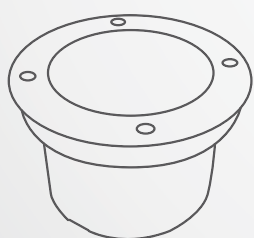

## **VANJSKA PODNA RASVJETA**

Vanjska podna rasvjeta stvara efektno i suptilno osvjetljenje, idealno za naglašavanje staza, vrtova i prilaza. Otporna na vremenske uvjete, dizajnirana je da pruži dugotrajno i pouzdano osvjetljenje koje podiže sigurnost i estetsku vrijednost prostora. Savršena je za isticanje pejzažnih elemenata i usmjeravanje kretanja u vanjskim područjima.



85-265 V/  
50-60 Hz

ID proizvoda	Snaga	CCT	Lumen	Dimenzije	Napon
G131-6W-RGB	6W	RGB	720 lm	Ø 90 x 80 mm	85 - 265 V
G131-6W-WW	6W	3000 K	720 lm	Ø 90 x 80 mm	85 - 265 V



DC 24 V

ID proizvoda	Snaga	CCT	Lumen	Dimenzije	Napon
M100-3W-WW	3W	3000 K	360 lm	Ø 100 x 80 mm	DC 24 V



ID proizvoda	Snaga	CCT	Lumen	Dimenzije	Napon
M150-6W-WW	6W	3000 K	720 lm	Ø 150 x 83 mm	DC 24 V

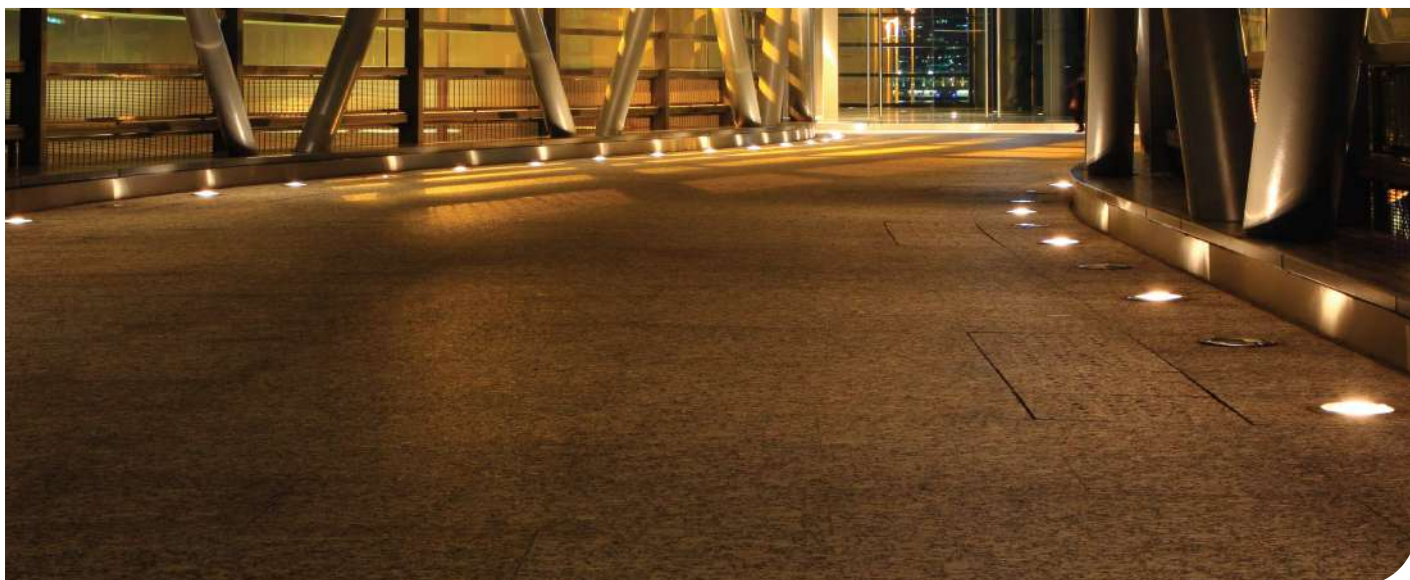

ID proizvoda

Snaga

CCT

Lumen

Dimenzije

Napon

M3020FS-1W-WW

1W

● 3000 K

100 lm

43 x 43 x 72 mm

DC 12 V



ID proizvoda

Snaga

CCT

Lumen

Dimenzije

Napon

MF180-9W-WW

9W

● 3000 K

900 lm

180 x 180 mm

AC 24 V





ID proizvoda	Snaga	CCT	Lumen	Dimenzije	Napon
ML200-6W-WW	6W	● 3000 K	600 lm	200 x 80 mm	AC 24 V

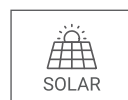

ID proizvoda	Snaga	CCT	Lumen	Dimenzije	Tip baterije
ULS-120-6W	6W	● 3000 K	480 lm	Ø 120 x 90 mm	3.7 V, 2200 mAh



## **VRTNA RASVJETA**

Vrtna rasvjeta omogućava elegantno osvjetljenje koje naglašava prirodne i dekorativne elemente vašeg vanjskog prostora. Otporna na vremenske uvjete, idealna je za osvjetljavanje staza, biljaka i terasa, stvarajući sigurno i privlačno okruženje. Uz različite stilove i opcije, vrtna rasvjeta doprinosi stvaranju savršenog ambijenta za opuštanje i druženje na otvorenom.



ID proizvoda	Snaga	Tip grla	Dimenzije	Napon
AB2745	max. 60 W	E27	80 x 80 x 440 mm	85 - 265 V
AB2745A	max. 60 W	E27	80 x 80 x 730 mm	85 - 265 V



ID proizvoda	Snaga	CCT	Lumen	Dimenzije	Napon
AB2805	12W	● 3000 K	1200 lm	Ø 150 x 650 mm	220 V



ID proizvoda	Snaga	CCT	Lumen	Dimenzije	Napon
AB2806	12W	● 3000 K	1200 lm	650 x 150 x 150 mm	220 V



ID proizvoda	Snaga	CCT	Lumen	Dimenzije	Napon
AB2846	12W	● 3000 K	1200 lm	800 x 210 x 85 mm	220 V





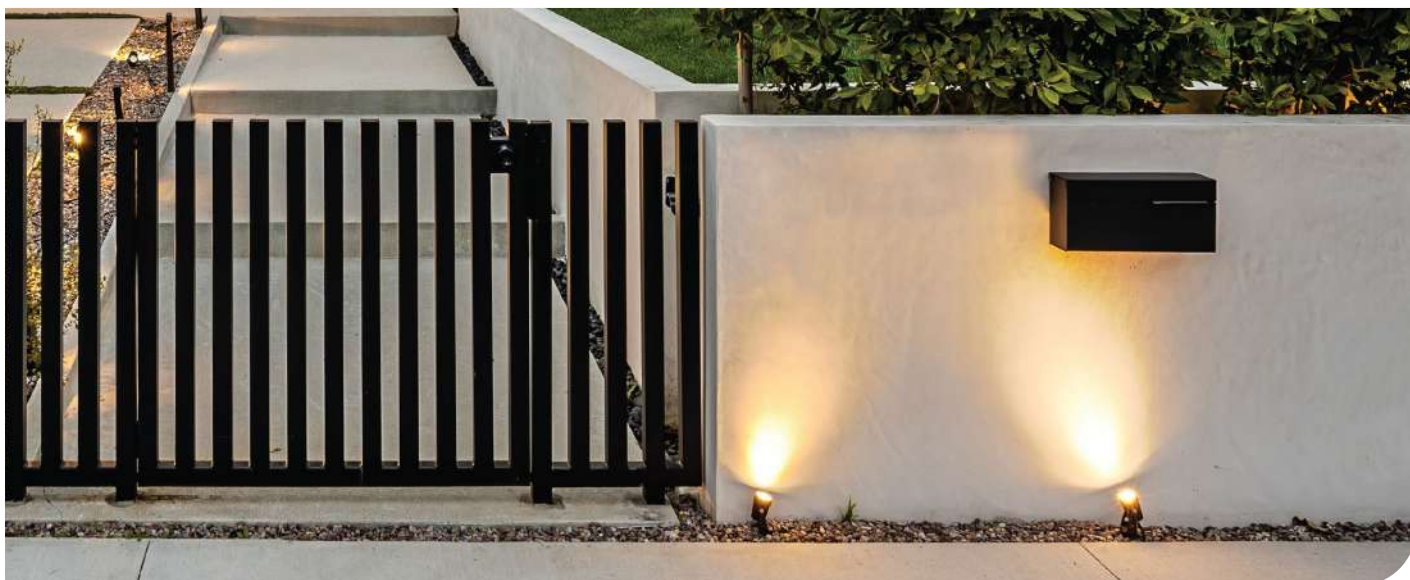

85-265 V/  
50-60 Hz

ID proizvoda

Snaga

CCT

Lumen

Dimenzije

Napon

G3025-3W-WW

3W

● 3000 K

360 lm

Ø 65 x 160 mm

85 - 265 V



85-265 V/  
50-60 Hz

ID proizvoda

Snaga

CCT

Lumen

Dimenzije

Napon

KFC-302

2 x 10W

● 3000 K

2 x 1000 lm

150 x 70 x 700 mm

85 - 265 V



85-265 V/  
50-60 Hz

ID proizvoda	Snaga	CCT	Lumen	Dimenzije	Napon
KFC-350	10W	● 3000 K	1000 lm	133 x 600 mm	85 - 265 V

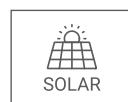

ID proizvoda	Snaga	CCT	Solarni panel	Dimenzije	Tip baterije
SLS-148-1	3.1W	● 3000 K	5.5 V monocrystal	210 x 210 x 370 mm	Litijska 3.7 V 2500 mAh

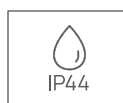
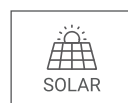

ID proizvoda	Snaga	CCT	Solarni panel	Dimenzije	Tip baterije
SLS-148-1S	3.1W	● 3000 K	5.5 V monocrystal	210 x 210 x 370 mm	Litijska 3.7 V 2500 mAh



## LED INDUSTRIJSKE VISILICE

LED industrijske visilice pružaju snažno i energetski učinkovito osvjetljenje, idealno za visoke stropove u proizvodnim halama, skladištima i radionicama. Dizajnirane za dugotrajnost i otpornost, ove visilice osiguravaju pouzdano osvjetljenje u zahtjevnim uvjetima, smanjujući troškove održavanja i potrošnju energije. S modernom LED tehnologijom, omogućuju jasnu vidljivost i sigurnost u industrijskim prostorima.





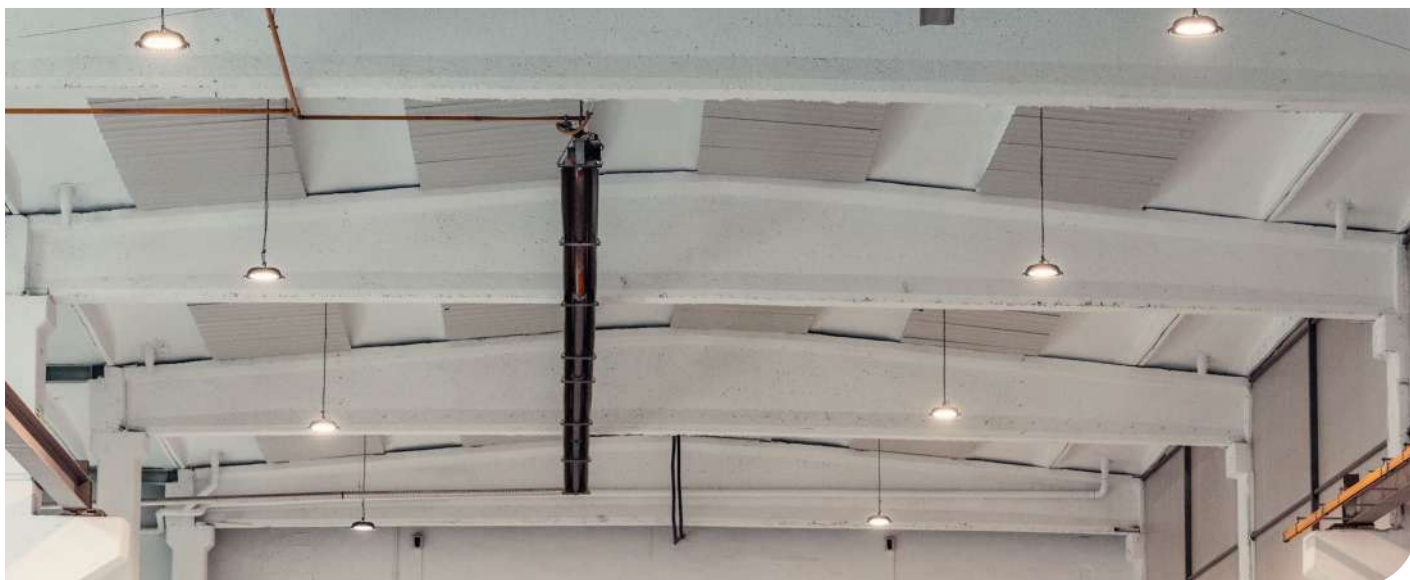

### CCT 3 U 1



220-240 V/  
50-60 Hz

ID proizvoda	Snaga	CCT	Lumen	Dimenzije	Napon
ILS-G2-100W	50W	<b>3 U 1</b> 4000 K   5000 K   5700 K	170 lm / W	Ø 250 x 146 mm	180 - 264 V
ILS-G2-150W	100W	<b>3 U 1</b> 4000 K   5000 K   5700 K	170 lm / W	Ø 290 x 148 mm	180 - 264 V
ILS-G2-200W	150W	<b>3 U 1</b> 4000 K   5000 K   5700 K	170 lm / W	Ø 330 x 150 mm	180 - 264 V

\* Podesiva snaga LED svjetiljke ILS-G2-100W - 60 W / 80 W / 100 W

\* Podesiva snaga LED svjetiljke ILS-G2-150W - 90 W / 120 W / 150 W

\* Podesiva snaga LED svjetiljke ILS-G2-200W - 120 W / 160 W / 200 W



CCT 3 U 1



**ILS-G2 serija**

# LED INDUSTRIJSKE SVJETILJKE





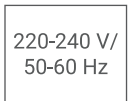

## LED VODOTIJESNE SVJETILJKE

LED vodotijesne svjetiljke pružaju pouzdano i izdržljivo osvjetljenje u uvjetima visoke vlage i prašine, idealne za garaže, podrum, industrijske pogone i vanjske prostore. Zahvaljujući vodonepropusnom dizajnu i dugotrajnoj LED tehnologiji, osiguravaju učinkovitu rasvjetu uz minimalne troškove održavanja. Njihova robusna konstrukcija omogućava optimalnu sigurnost i performanse čak i u zahtjevnim okruženjima.





ID proizvoda	Snaga	CCT	Lumen	Dimenzije	Napon
WP-BD-30W-3CCT	30W	 <b>3 U 1</b> 3000 K   4000 K   6500 K	3000 lm	75 x 52 x 600 mm	220 - 240 V
WP-BD-60W-3CCT	60W	 <b>3 U 1</b> 3000 K   4000 K   6500 K	6000 lm	75 x 52 x 1200 mm	220 - 240 V
WP-BD-70W-3CCT	70W	 <b>3 U 1</b> 3000 K   4000 K   6500 K	7000 lm	75 x 52 x 1500 mm	220 - 240 V

\* LED svjetiljka WP-BD-30W-3CCT podržava povezivanje do 12 svjetiljki u nizu

\* LED svjetiljka WP-BD-60W-3CCT podržava povezivanje do 6 svjetiljki u nizu

\* LED svjetiljka WP-BD-70W-3CCT podržava povezivanje do 5 svjetiljki u nizu



ID proizvoda	Snaga	CCT	Lumen	Dimenzije	Napon
WP-Q18W-3CCT	18W	 <b>3 U 1</b> 3000 K   4000 K   6500 K	2160 lm	650 x 61 x 56 mm	160 - 240 V
WP-Q36W-3CCT	36W	 <b>3 U 1</b> 3000 K   4000 K   6500 K	4320 lm	1250 x 61 x 56 mm	160 - 240 V
WP-Q45W-3CCT	45W	 <b>3 U 1</b> 3000 K   4000 K   6500 K	5400 lm	1550 x 61 x 56 mm	160 - 240 V

\* LED svjetiljka WP-Q18W-3CCT podržava povezivanje do 33 svjetiljke u nizu

\* LED svjetiljka WP-Q36W-3CCT podržava povezivanje do 16 svjetiljki u nizu

\* LED svjetiljka WP-Q45W-3CCT podržava povezivanje do 13 svjetiljki u nizu



**CCT 3 U 1**

3000K 4200K 6500K



220-240 V/  
50-60 Hz



ID proizvoda	Snaga	CCT	Lumen	Dimenzije	Napon
LWF-636-15W	15W	<b>3 U 1</b> 3000 K   4200 K   6500 K	2100 lm	636 x 102 x 81 mm	220 - 240 V
LWF-1176-34W	34W	<b>3 U 1</b> 3000 K   4200 K   6500 K	4760 lm	1176 x 102 x 81 mm	220 - 240 V
LWF-1506-55W	55W	<b>3 U 1</b> 3000 K   4200 K   6500 K	7700 lm	1506 x 102 x 81 mm	220 - 240 V

220-240 V/  
50-60 Hz

ID proizvoda	Namjena	Dimenzije	Napon
WP-G2-600-2X9	Za montažu 2 x LED T8 cijevi od 600 mm	655 x 112 x 53 mm	220 - 240 V
WP-G2-1200-2X18	Za montažu 2 x LED T8 cijevi od 1200 mm	1265 x 112 x 53 mm	220 - 240 V
WP-G2-1500-2X25	Za montažu 2 x LED T8 cijevi od 1500 mm	1565 x 112 x 53 mm	220 - 240 V

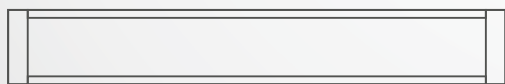

## LED CIJEVI

LED cijevi nude energetski učinkovitu i dugotrajnu zamjenu za klasične fluorescentne cijevi, pružajući svjetlo i ravnomjerno osvjetljenje. Idealne su za primjenu u uredima, skladištima, trgovinama i industrijskim prostorima. S brzim i jednostavnim postavljanjem, LED cijevi smanjuju potrošnju energije i troškove održavanja, osiguravajući pouzdano osvjetljenje s duljim vijekom trajanja.



**CCT 3 U 1**

 220-240 V/  
50-60 Hz

ID proizvoda	Snaga	CCT	Lumen	Dimenzije	Napon
PF-18W-3CCT	18W	<b>3 U 1</b> 3000 K   4000 K   6500 K	1800 lm	75 x 23 x 600 mm	220 - 240 V
PF-36W-3CCT	36W	<b>3 U 1</b> 3000 K   4000 K   6500 K	3600 lm	75 x 23 x 1200 mm	220 - 240 V
PF-45W-3CCT	45W	<b>3 U 1</b> 3000 K   4000 K   6500 K	4500 lm	75 x 23 x 1500 mm	220 - 240 V

185-265 V/  
50-60 Hz

ID proizvoda	Snaga	CCT	Lumen	Dimenzije	Napon
T5-S30-5NW	5W	● 4000K	500 lm	312 x 35 x 22 mm	185 - 265 V
T5-S60-9NW	9W	● 4000K	900 lm	582 x 35 x 22 mm	185 - 265 V
T5-S120-18NW	18W	● 4000K	1800 lm	1200 x 35 x 22 mm	185 - 265 V

175-265 V/  
50-60 Hz

ID proizvoda	Snaga	CCT	Lumen	Dimenzije	Napon
T8-G3-10W-CW	10W	● 6000K	1000 lm	Ø 28 x 588 mm	175 - 265 V
T8-G3-10W-NW	10W	● 4200K	1000 lm	Ø 28 x 588 mm	175 - 265 V
T8-G3-18W-CW	18W	● 6000K	1800 lm	Ø 28 x 1197 mm	175 - 265 V
T8-G3-18W-NW	18W	● 4200K	1800 lm	Ø 28 x 1197 mm	175 - 265 V
T8-G2-24W-NW	24W	● 4200K	2400 lm	Ø 28 x 1497 mm	175 - 265 V
T8-G3-24W-CW	24W	● 6000K	2400 lm	Ø 28 x 1497 mm	175 - 265 V



ID proizvoda	Snaga	CCT	Lumen	Dimenzije	Napon
T801-1500-25-NW	25W	● 4200K	2500 lm	Ø 28 x 1500 mm	220 V

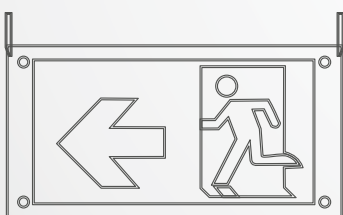

## LED NUŽNA RASVJETA

Za pouzdano osvijetljenje u hitnim situacijama, LED nužna rasvjeta omogućuje sigurno kretanje i evakuaciju u slučaju nestanka struje. Dizajnirana da automatski aktivira svjetlo tijekom neočekivanih prekida, ova rasvjeta je ključna za hodnike, izlaze i zajedničke prostore u poslovnim i javnim objektima. Dugotrajna i energetske učinkovita, panik rasvjeta pruža dodatnu sigurnost kad je najpotrebnija.

220-240 V/  
50-60 Hz

ID proizvoda	Snaga	CCT	Lumen	Dimenzije	Tip baterije
EL01-3LF	3W	● 6000 K	150 lm	308 x 47 x 236 mm	LiFePO4 3.2 V 1500 mAh



ID proizvoda	Snaga	CCT	Lumen	Dimenzije	Tip baterije
EL03-6LF	2 x 3W	● 6000 K	150 lm	140 x 125 x 38 mm	LiFePO4 3.2 V 1500 mAh



ID proizvoda	Snaga	CCT	Lumen	Dimenzije	Tip baterije
EL04-3L	3W	● 6000 K	160 ~ 170 lm	350 x 70 x 110 mm	LiFePO4 3.2 V 1500 mAh

220-240 V/  
50-60 Hz

ID proizvoda	Snaga	CCT	Lumen	Dimenzije	Tip baterije
EL05-3LF-D	3W	● 6000 K	150 lm	Ø 143 x 20 mm	LiFePO4 3.2 V 1500 mAh



ID proizvoda	Snaga	CCT	Lumen	Dimenzije	Tip baterije
ELW-9W	9W	● 6000 K	810 lm	Ø 70 x 142 mm	Li-ion 3.7 V 1200 mAh

176-265 V/  
50-60 Hz

ID proizvoda	Snaga	CCT	Lumen	Dimenzije	Tip baterije
ELX-3W-NW	3W	● 4200 K	150 lm	90 x 260 x 50 mm	Li-ion 3.7 V 2200 mAh



**EXIT  
IZLAZ**

ID proizvoda	Namjena	Dimenzije
ELX-BLADEKIT	Za ovjesnu montažu na LED svjetiljku ELX-3W-NW	220 x 111 mm



ID proizvoda	Namjena	Dimenzije
ELX-FRAME	Za ugradnu montažu LED svjetiljke ELX-3W-NW	297 x 132 mm

240 V/  
50-60 Hz

ID proizvoda	Snaga	CCT	Usmjerenje	Dimenzije	Tip baterije
EPK-A14	3W	● 6500 K	dvostrano	330 x 145 x 22 mm	Ni-CD 1.2 V 800 mAh



ID proizvoda	Snaga	CCT	Usmjerenje	Dimenzije	Tip baterije
EPK-A5	3W	● 6500 K	dvostrano	355 x 145 x 22 mm	Ni-CD 3.6 V





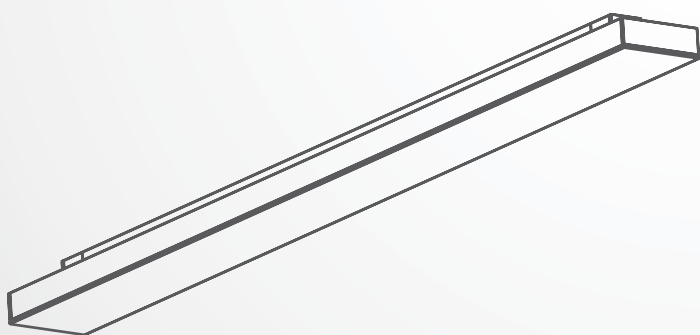

## LED LINEARNE SVJETILJKE

LED linearne svjetiljke pružaju elegantno i ravnomjerno osvjetljenje, idealne za moderne interijere. Dostupne kao ugradne, nadgradne ili visilice, lako se prilagođavaju različitim prostorima i potrebama, od ureda i komercijalnih prostora do kućnih interijera. Zahvaljujući energetskej učinkovitosti i dugotrajnosti, LED linearne svjetiljke nude fleksibilnost u dizajnu i visokokvalitetnu rasvjetu uz niske troškove održavanja.

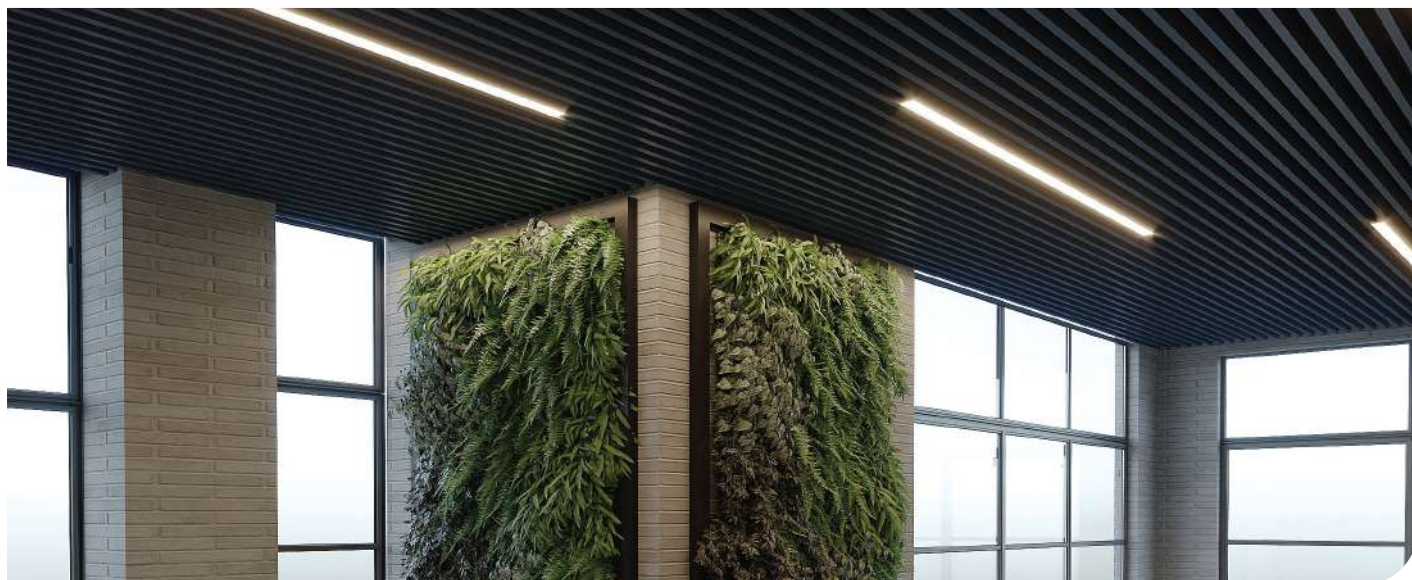

OSRAM



220 V

ID proizvoda	Snaga	CCT	Lumen	Duljina	Napon
UPL-1000-01	40W	● 4000 K	4800 lm	1000 mm	220 V
UPL-1000-02	20W	● 4000 K	2400 lm	1000 mm	220 V
UPL-1500-01	60W	● 4000 K	7200 lm	1500 mm	220 V
UPL-1500-02	30W	● 4000 K	3600 lm	1500 mm	220 V
UPL-2000-01	80W	● 4000 K	9600 lm	2000 mm	220 V
UPL-2000-02	40W	● 4000 K	4800 lm	2000 mm	220 V

- \* Mogućnost izbora boje svjetlosti: 2700 K | 3000 K | 4000 K
- \* Mogućnost izbora duljine svjetiljke (maksimalno 2000 mm)
- \* Mogućnost izbora boje kućišta po RAL karti



OSRAM



220 V

ID proizvoda	Snaga	CCT	Lumen	Duljina	Napon
NPL-1000-01	35W	● 3000 K	3150 lm	1000 mm	220 V
NPL-1000-02	17W	● 3000 K	1530 lm	1000 mm	220 V
NPL-1500-01	50W	● 3000 K	4750 lm	1500 mm	220 V
NPL-1500-02	25W	● 3000 K	2375 lm	1500 mm	220 V
NPL-2000-01	70W	● 3000 K	6300 lm	2000 mm	220 V
NPL-2000-02	35W	● 3000 K	3150 lm	2000 mm	220 V

\* Mogućnost izbora boje svjetlosti: 3000 K | 4000 K

\* Mogućnost izbora duljine svjetiljke (maksimalno 2000 mm)

\* Mogućnost izbora boje kućišta po RAL karti

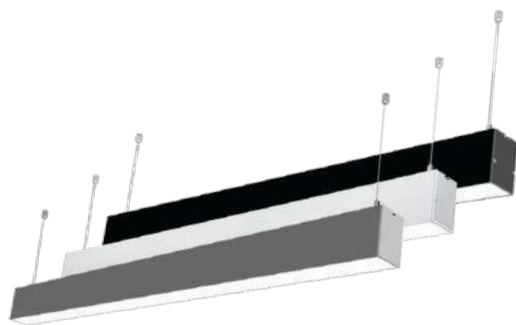

ID proizvoda	Snaga	CCT	Lumen	Duljina	Napon
L-750-01	40W	● 3000 K	5400 lm	750 mm	220 V
L-750-02	20W	● 3000 K	2700 lm	750 mm	220 V
L-1000-01	35W	● 2700 K	4025 lm	1000 mm	220 V
L-1000-02	20W	● 2700 K	2100 lm	1000 mm	220 V
L-1200-01	70W	● 3000 K	8750 lm	1200 mm	220 V
L-1200-02	35W	● 3000 K	4375 lm	1200 mm	220 V
L-1500-01	60W	● 2700 K	6000 lm	1500 mm	220 V
L-1500-02	35W	● 2700 K	3150 lm	1500 mm	220 V
L-1800-01	100W	● 3000 K	13000 lm	1800 mm	220 V
L-1800-02	60W	● 3000 K	1200 lm	1800 mm	220 V
L-2000-01	70W	● 2700 K	8050 lm	2000 mm	220 V
L-2000-02	35W	● 2700 K	4025 lm	2000 mm	220 V
L-2200-01	120W	● 3000 K	16200 lm	2200 mm	220 V
L-2200-02	60W	● 3000 K	8100 lm	2200 mm	220 V
L-2500-01	95W	● 2700 K	10450 lm	2500 mm	220 V
L-2500-02	50W	● 2700 K	5000 lm	2500 mm	220 V

\* Mogućnost izbora boje svjetlosti: 2700 K | 3000 K | 4000 K  
 \* Mogućnost izbora duljine svjetiljke (maksimalno 3000 mm)  
 \* Mogućnost izbora boje kućišta po RAL karti





OSRAM



220 V

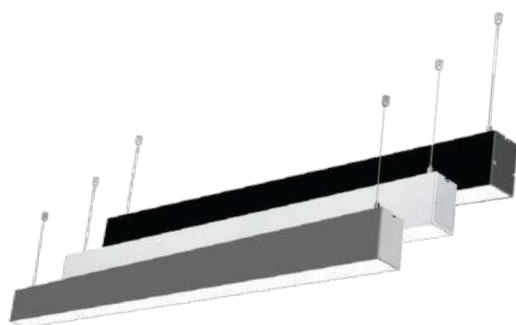

ID proizvoda	Snaga	CCT	Lumen	Duljina	Napon
L-2700-01	155W	● 3000 K	19375 lm	2700 mm	220 V
L-2700-02	75W	● 3000 K	9750 lm	2700 mm	220 V
L-3000-01	115W	● 2700 K	12075 lm	3000 mm	220 V
L-3000-02	55W	● 2700 K	6050 lm	3000 mm	220 V

- \* Mogućnost izbora boje svjetlosti: 2700 K | 3000 K | 4000 K
- \* Mogućnost izbora duljine svjetiljke (maksimalno 3000 mm)
- \* Mogućnost izbora boje kućišta po RAL karti







OSRAM

85-265 V/  
50-60 Hz

ID proizvoda	Snaga	CCT	Lumen	Duljina	Napon
L170	48W	● 4000 K	5760 lm	1279 mm	85 - 265 V



ID proizvoda	Snaga	CCT	Lumen	Duljina	Napon
L177	48W	● 4000 K	5760 lm	1279 mm	85 - 265 V



OSRAM



220 V

ID proizvoda	Snaga	CCT	Lumen	Duljina	Napon
L1190	54W	● 4000   4200 K	5400 lm	1437 mm	220 V



OSRAM



220 V



ID proizvoda	Snaga	CCT	Lumen	Duljina	Napon
L190	48W	● 4000 K	4800 lm	1279 mm	220 V



220 V



ID proizvoda	Snaga	CCT	Lumen	Duljina	Napon
L1774	40W	● 4000 K	4800 lm	1420 mm	220 V

OSRAM



220 V



ID proizvoda	Snaga	CCT	Lumen	Duljina	Napon
L2000	64W	● 4000 K	6400 lm	2000 mm	220 V



## LED UREDSKE VISILICE

Funkcionalno i moderno rješenje za osvjetljenje, ove LED visilice savršeno su prilagođene uredskim prostorima kojima je potrebno ravnomjerno i ugodno svjetlo. Zahvaljujući visokoj energetskej učinkovitosti, doprinose ugodnom radnom okruženju uz niske troškove potrošnje. S mogućnošću prilagodbe visine, lako se uklapaju u različite uredske postavke, pružajući kvalitetnu rasvjetu za produktivniji radni prostor.





220-240 V/  
50-60 Hz



ID proizvoda	Snaga	CCT	Lumen	Dimenzije	Napon
LLP-40W	40W	<b>3 U 1</b> 3000 K   4000 K   5700 K	4800 lm	1200 x 300 x 27 mm	220 - 240 V



ID proizvoda	Snaga	CCT	Lumen	Dimenzije	Napon
LLS-60W	60W	<b>3 U 1</b> 3000 K   4000 K   5700 K	6000 lm	1500 x 171 x 55 mm	220 - 240 V

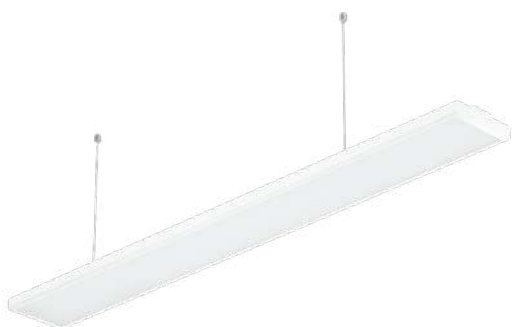

ID proizvoda	Snaga	CCT	Lumen	Dimenzije	Napon
LLW-60W	60W	<b>3 U 1</b> 3000 K   4000 K   5700 K	6000 lm	1500 x 150 x 34 mm	220 - 240 V



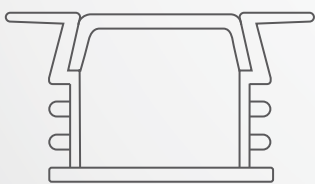

## ALUMINIJSKI **PROFILI**

Aluminijski profili pružaju čvrst i elegantan okvir za instalaciju LED traka, štiteći ih od oštećenja i osiguravajući ravnomjerno osvjetljenje. Laki za montažu i dugotrajan, ovaj dodatak omogućuje besprijekorno postavljanje LED traka uz estetski ugodan izgled. Idealni su za korištenje u unutarnjim prostorima poput kuhinja, hodnika, ali i za vanjsku primjenu, nudeći dodatnu zaštitu i dugovječnost rasvjeti.

2 m/kom



ID proizvoda	Način montaže	Dimenzije
AP-10MM01	Nadgradni	19,1 x 8 x 1000 mm



ID proizvoda	Način montaže	Dimenzije
AP-10MM02	Nadgradni	16 x 16 x 1000 mm



ID proizvoda	Način montaže	Dimenzije
AP-10MM02-BK	Nadgradni	16 x 16 x 1000 mm



ID proizvoda	Način montaže	Dimenzije
AP-10MM03	Nadgradni	16 x 16 x 1000 mm



ID proizvoda	Način montaže	Dimenzije
AP-11MM02	Nadgradni	15,9 x 8 x 1000 mm

2 m/kom



ID proizvoda	Način montaže	Dimenzije
AP-11MM04	Nadgradni	16 x 12 x 1000 mm



ID proizvoda	Način montaže	Dimenzije
AP-11MM04-BK	Nadgradni	16 x 12 x 1000 mm



ID proizvoda	Način montaže	Dimenzije
AP-12MM06	Nadgradni	53 x 8,47 x 1000 mm



ID proizvoda	Način montaže	Dimenzije
AP-12MM07	Nadgradni	21,3 x 25,9 x 1000 mm



ID proizvoda	Način montaže	Dimenzije
AP-1806A	Nadgradni	17,9 x 5,7 x 1000 mm





2 m/kom



ID proizvoda	Način montaže	Dimenzije
AP-3030Y	Nadgradni	Ø 30 x 1000 mm



ID proizvoda	Način montaže	Dimenzije
AP-3420	Nadgradni	26,3 x 19,6 x 1000 mm

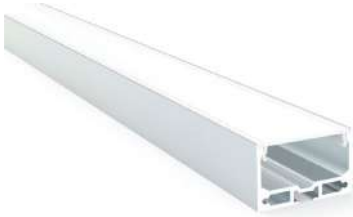

ID proizvoda	Način montaže	Dimenzije
AP-4025	Nadgradni	39,91 x 24,81 x 1000 mm



ID proizvoda	Način montaže	Dimenzije
AP-5050	Nadgradni	50 x 50 x 1000 mm



ID proizvoda	Način montaže	Dimenzije
AP-5070	Nadgradni	50 x 70 x 1000 mm

2 m/kom



ID proizvoda

Način montaže

Dimenzije

AP-8MM01

Nadgradni

12 x 7,8 x 1000 mm



ID proizvoda

Način montaže

Dimenzije

APN-277B

Nadgradni

21 x 21 x 2000 mm



ID proizvoda

Način montaže

Dimenzije

AP-11MM03

Ugradni

21,5 x 6,8 x 1000 mm



ID proizvoda

Način montaže

Dimenzije

AP-11MM03-BK

Ugradni

21,5 x 6,8 x 1000 mm



ID proizvoda

Način montaže

Dimenzije

AP-11MM05

Ugradni

22 x 11,7 x 1000 mm

2 m/kom



ID proizvoda

Način montaže

Dimenzije

AP-11MM05-BK

Ugradni

22 x 11,7 x 1000 mm



ID proizvoda

Način montaže

Dimenzije

AP-2711

Ugradni

27,2 x 10,9 x 1000 mm



ID proizvoda

Način montaže

Dimenzije

AP-2911

Ugradni

28,63 x 11 x 1000 mm



ID proizvoda

Način montaže

Dimenzije

AP-353502

Ugradni

45 x 34,9 x 1000 mm



ID proizvoda

Način montaže

Dimenzije

AP-3628

Ugradni

36 x 28 x 1000 mm



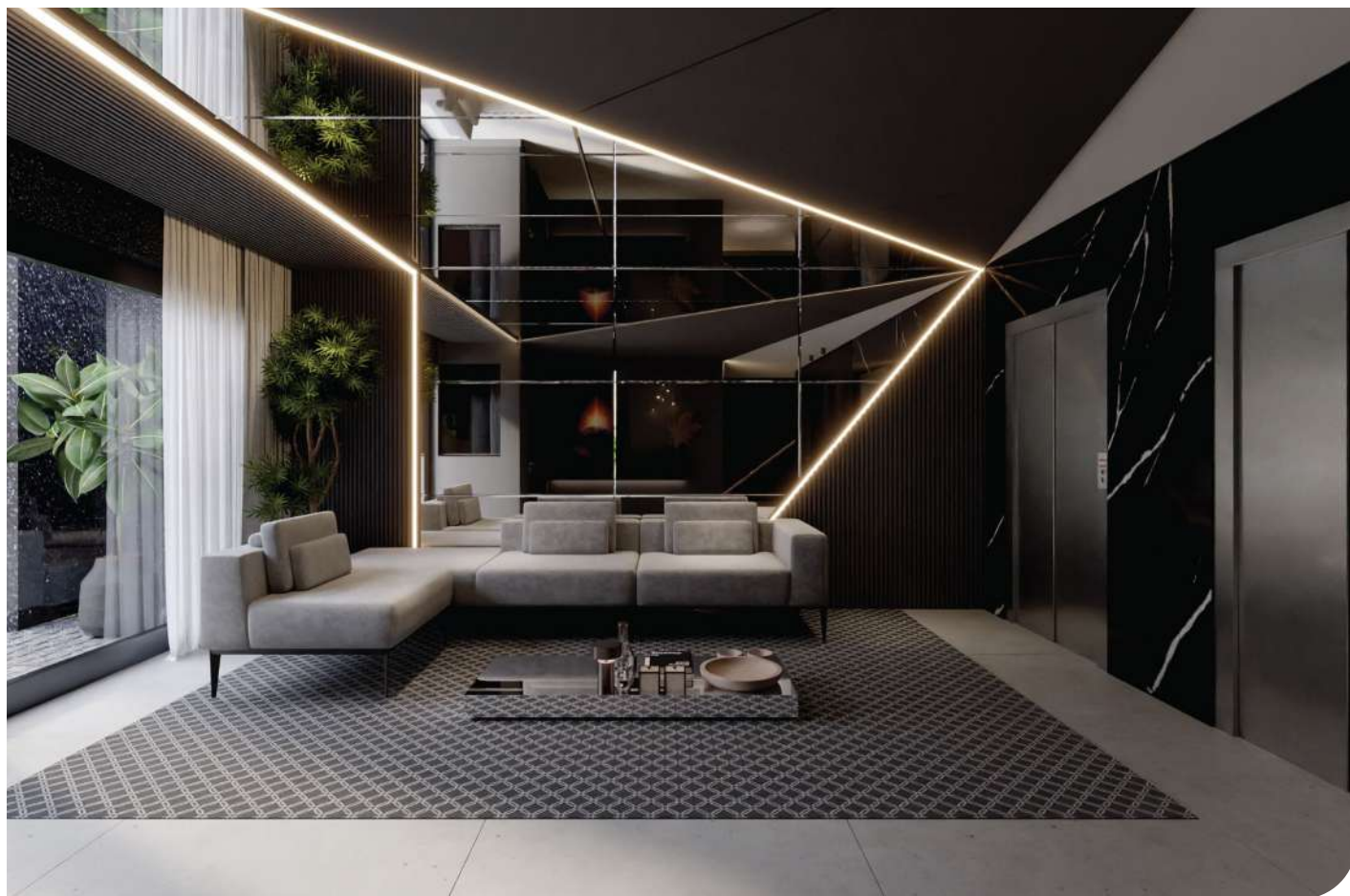

2 m/kom

 IP20

ID proizvoda

Način montaže

Dimenzije

AP-5035

Ugradni

50 x 35 x 1000 mm



ID proizvoda

Način montaže

Dimenzije

AP-5213

Ugradni

53 x 13,8 x 1000 mm



ID proizvoda

Način montaže

Dimenzije

AP-6214

Ugradni

28,2 x 13,8 x 1000 mm



ID proizvoda

Način montaže

Dimenzije

AP-7419

Ugradni

74,85 x 15,90 x 1000 mm



ID proizvoda

Način montaže

Dimenzije

AP-9032

Ugradni

90 x 32 x 1000 mm



ID proizvoda

Dimenzije

CL-002

30 x 68 x 33 mm

\* Za ugradnu montažu aluminijskih profila AP-3628 i AP-5035



ID proizvoda

Dimenzije

CL-003

40 x 81 x 21mm

\* Za ugradnu montažu aluminijskih profila AP-9032

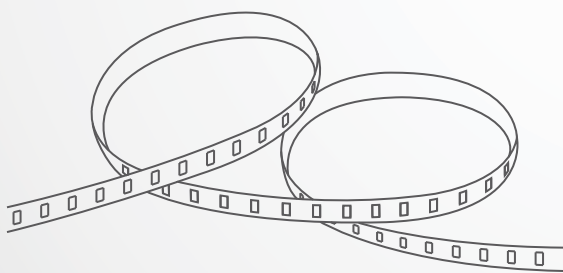

## LED TRAKE

Kao fleksibilno i prilagodljivo rješenje LED trake omogućuju kreativno osvjetljenje za interijere i eksterijere, naglašavajući posebne detalje prostora. Jednostavne za instalaciju i dostupne u raznim bojama, idealne su za dekorativnu rasvjetu u domovima, poslovnim prostorima, restoranima i drugim okruženjima. Uz energetska učinkovitost i dugotrajnost, unose modernu atmosferu i dodatnu estetiku.





ID proizvoda	Snaga	CCT	Lumen	Broj dioda
COB320244000IP20	4.5 W/m	● 4000 K	106 lm / W	320 dioda/m
COBRGBCTA84024	18 W/m	●●● 2700 K   6500 K   RGB	83 lm / W	840 dioda/m
S120243000IP20	10 W/m	● 3000 K	102 lm / W	120 dioda/m
S120244000IP20	10 W/m	● 4000 K	104 lm / W	120 dioda/m
S120246000IP20	10 W/m	● 6000 K	104 lm / W	120 dioda/m
S160242700IP20	14,4 W/m	● 2700 K	138 lm / W	160 dioda/m
S160244000IP20	14,4 W/m	● 4000 K	150 lm / W	160 dioda/m
S160246000IP20	14,4 W/m	● 6000 K	146 lm / W	160 dioda/m
S6024RGBIP20	11,5 W/m	●●● RGB	36 lm / W	60 dioda/m
S80122700IP20	9,6 W/m	● 2700 K	138 lm / W	80 dioda/m
S80124000IP20	9,6 W/m	● 4000 K	150 lm / W	80 dioda/m
S80126000IP20	9,6 W/m	● 6000 K	110 lm / W	196 dioda/m



ID proizvoda	Snaga	CCT	Lumen	Broj dioda
COB320242700IP65	8 W/m	● 2700 K	77 lm / W	320 dioda/m
COB320244000IP65	8 W/m	● 4000 K	92 lm / W	320 dioda/m
COB420243000IP65	8 W/m	● 3000 K	80 lm / W	420 dioda/m
COB420244000IP65	8 W/m	● 4000 K	90 lm / W	420 dioda/m
COBCTA60824IP65	2 x 7 W/m	●● 2700 K   6500 K	90 lm / W	608 dioda/m
S12024RGBWIP65	14,4 W/m	●●● 3000 K   RGB	55 lm / W	120 dioda/m
S160242700IP65	14,4 W/m	● 2700 K	128 lm / W	160 dioda/m
S160244000IP65	14,4 W/m	● 4000 K	140 lm / W	160 dioda/m
S160246000IP65	14,4 W/m	● 6000 K	136 lm / W	160 dioda/m
S196243000IP65	20 W/m	● 3000 K	104 lm / W	196 dioda/m
S196244000IP65	20 W/m	● 4000 K	110 lm / W	196 dioda/m
S6024RGBIP65	11,5 W/m	●●● RGB	35 lm / W	60 dioda/m
S80122700IP65	9,6 W/m	● 2700 K	128 lm / W	80 dioda/m
S80124000IP65	9,6 W/m	● 4000 K	140 lm / W	80 dioda/m
S80126000IP65	9,6 W/m	● 6000 K	136 lm / W	80 dioda/m





DC 5 V



ID proizvoda	Snaga	CCT	Lumen	Broj dioda	Duljina
LSU-USB1M	7,2 W/m	RGB	66 lm / m	30 dioda/m	1000 mm
LSU-USB2M	7,2 W/m	RGB	66 lm / m	30 dioda/m	2000 mm







## LED **KONTROLERI, POJAČALA I DIMMERI**

Potpuna kontrola nad intenzitetom, bojom i efektima LED rasvjete postiže se pomoću kontrolera, dimmera i pojačala. Kontroleri omogućuju odabir boja i svjetlosnih scena, dimmeri prilagođavaju jačinu svjetla prema potrebi, dok pojačala održavaju stabilnu snagu za duže LED trake, osiguravajući konzistentan i pouzdan rad rasvjete.



ID proizvoda	Snaga	Tip
LCS-010	5 V < 30 W, 12 V < 72 W	RGB (3 kanala)

- \* Napon: DC 5 - 12 V
- \* Maksimalna struja: 3 kanala x 2 A



ID proizvoda	Snaga	Tip
LCS-032	12 V < 288 W, 24 V < 576 W	RGBW (4 kanala)

- \* Napon: DC 12 - 24 V
- \* Maksimalna struja: 4 kanala x 6 A



ID proizvoda	Snaga	Tip
LCS-040	12 V < 288 W, 24 V < 576 W	RGB (3 kanala)

- \* Napon: DC 12 - 24 V
- \* Maksimalna struja: 3 kanala x 8 A



ID proizvoda	Snaga	Tip
LCS-090	12 V < 1440 W, 24 V < 2880 W	RGB (3 kanala)

- \* Napon: DC 12 - 24 V
- \* Maksimalna struja: 3 kanala x 40 A



ID proizvoda	Snaga	Tip
LCS-L2B-R0CT	5 V < 20 W, 12 V < 48 W, 24 V < 96 W	CCT (2 kanala)

- \* Napon: DC 5 - 24 V
- \* Maksimalna struja: 2 kanala x 4 A



ID proizvoda	Snaga	Tip
LCS-TIH-QTC	12 V < 144 W, 24 V < 288 W	CCT (2 kanala)

- \* Napon: DC 12 - 24 V
- \* Maksimalna struja: 2 kanala x 6 A



ID proizvoda	Snaga	Tip
LCS-WIFI03-01	12 V < 288 W, 24 V < 576 W	RGB (3 kanala)

- \* Napon: DC 12 - 24 V
- \* Maksimalna struja: 3 kanala x 8 A
- \* Aplikacija: Tuya Smart



ID proizvoda	Snaga	Tip
LCS-080	12 V < 216 W, 24 V < 432 W	RGB (3 kanala)

- \* Napon: DC 12 - 24 V
- \* Maksimalna struja: 3 kanala x 8 A



ID proizvoda	Snaga	Tip
LCS-TIH-AMF	12 V < 288 W, 24 V < 576 W	RGB (3 kanala)

- \* Napon: DC 12 - 24 V
- \* Maksimalna struja: 3 kanala x 8 A



ID proizvoda	Snaga	Tip
LCS-TIH-QDC	12 V < 288 W, 24 V < 576 W	RF (3 kanala)

- \* Napon: DC 12 - 24 V
- \* Maksimalna struja: 3 kanala x 8 A





ID proizvoda	Snaga	Tip
LC-DIM	12 V < 96 W, 24 V < 192 W	Jednobojni (1 kanal)

- \* Napon: DC 12 - 24 V
- \* Maksimalna struja: 8 A

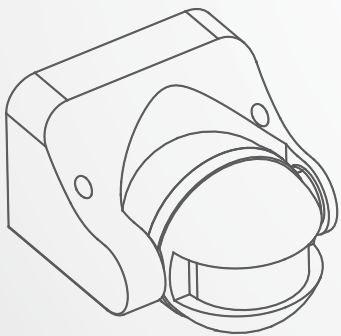

## SENZORI I DETEKTORI

Automatsko upravljanje rasvjetom i ušteda energije postižu se pomoću senzora pokreta i luksomata. Senzori pokreta aktiviraju rasvjetu kada otkriju prisutnost, čime povećavaju sigurnost i smanjuju potrošnju energije. Luksomati omogućuju prilagodbu osvjetljenja prema dnevnoj svjetlosti, automatski uključujući ili isključujući rasvjetu, što doprinosi optimalnoj energetskej učinkovitosti i udobnosti u prostoru.



200-240 V/  
50-60 Hz

ID proizvoda	Max. opterećenje	Kut detekcije	Domet detekcije	Napon
IMS05	1200 W	360 °	Do 6 m	200 - 240 V



220-240 V/  
50-60 Hz

ID proizvoda	Max. opterećenje	Kut detekcije	Domet detekcije	Napon
IMS05C-BK	2000 W	360°	Do 8 m	220 - 240 V



ID proizvoda	Max. opterećenje	Kut detekcije	Domet detekcije	Napon
IMS05C-WH	2000 W	360°	Do 8 m	220 - 240 V



220-240 V/  
50-60 Hz

ID proizvoda	Max. opterećenje	Kut detekcije	Domet detekcije	Napon
IMS09	1200 W	180°	Do 12 m	220 - 240 V



200-240 V/  
50-60 Hz

ID proizvoda	Max. opterećenje	Kut detekcije	Domet detekcije	Napon
IMS11	1200 W	360°	Do 12 m	200 - 240 V



220-240 V/  
50-60 Hz

ID proizvoda	Max. opterećenje	Kut detekcije	Domet detekcije	Napon
IMS12	800 W	180°	Do 12 m	220 - 240 V





220-240 V/  
50-60 Hz



ID proizvoda	Max. opterećenje	Kut detekcije	Domet detekcije	Napon
IMS40A	800 W	360°	Do 8 m	220 - 240 V



ID proizvoda	Max. opterećenje	Kut detekcije	Domet detekcije	Napon
IMS41	1200 W	360°	Do 6 m	200 - 240 V



ID proizvoda	Max. opterećenje	Kut detekcije	Domet detekcije	Napon
MWS15	1200 W	360° / 180°	Do 15 m	220 - 240 V



200-240 V/  
50-60 Hz

ID proizvoda	Max. opterećenje	Struja	Podesiva svjetlost	Napon
PHC-301	1200 W	6 A	< 5 - 15 LUX	200 - 240 V



ID proizvoda	Max. opterećenje	Struja	Podesiva svjetlost	Napon
PHC-302	1200 W	10 A	< 5 - 50 LUX LUX	200 - 240 V



220-240 V/  
50-60 Hz

ID proizvoda	Max. opterećenje	Struja	Podesiva svjetlost	Napon
PHC-309C	3000 W	25 A	< 5 - 50 LUX	220 - 240 V







save energy | save planet | save future   
**Green tech**

**KATALOG**

LED RASVJETA

**2025**

[info@greentech-solution.eu](mailto:info@greentech-solution.eu)